

PoC Filter Solution – SMD-POC-032

Overview

The SMD-POC-032 is for PoC applications spanning an 8 MHz to 3 GHz frequency range, injecting a current of 0.3 Amps. The impedance measurement was generated in simulation using measured Z-Parameter files for each component. S-Parameters were generated by taking two SMD-POC-032 boards connected by Leoni Dacar-302 coaxial cable. Using a DC Power supply, the DC_{in} was connected to CON3 of the first board, while the DC_{out} was connected to the CON3 of the second board to close the circuit. All measurements were at room temperature and are considered typical responses for the solution.

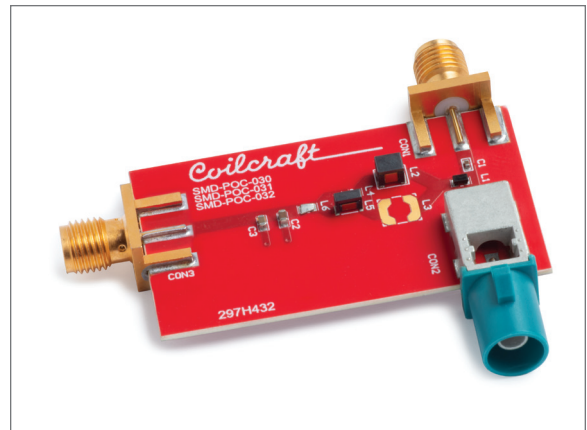

Coilcraft 300 mA Solution

Inductors	DCR max. (Ohms)	Max. Area (mm ²)	Isat (A) 30%		Irms (A)		Notes
			25°C	125°C	25°C	125°C	
PFL1609-561 (0.56 µH)	0.130	1.926	1.10	0.61	1.40 (40°C rise)	0.80 (15°C rise)	
1210POC-223 (22 µH)	0.880	8.811	0.72	0.45	0.70 (40°C rise)	0.40 (15°C rise)	
1205POC-103 (10 µH)	1.000	4.48	0.67	0.41	0.56 (40°C rise)	0.30 (15°C rise)	
Totals:	2.01	15.217					

Schematic

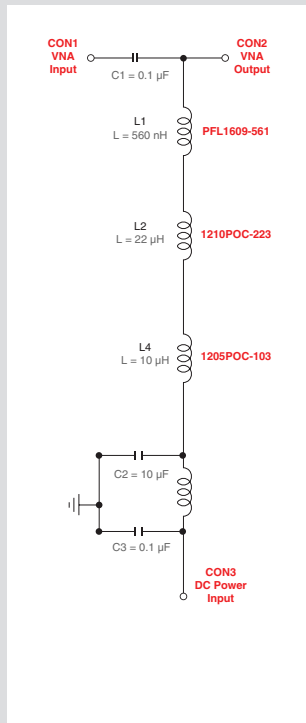

Impedance vs. Frequency

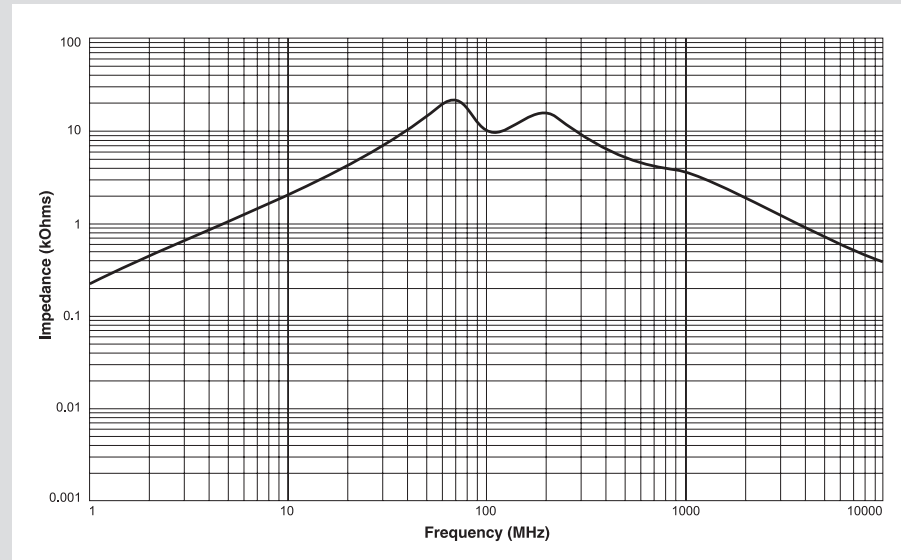

PoC Filter Solution – SMD-POC-032

Return Loss (2 m cable)

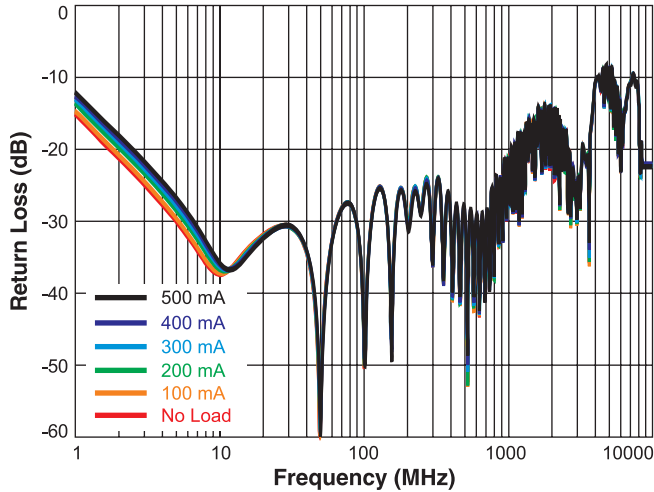

Return Loss (10 m cable)

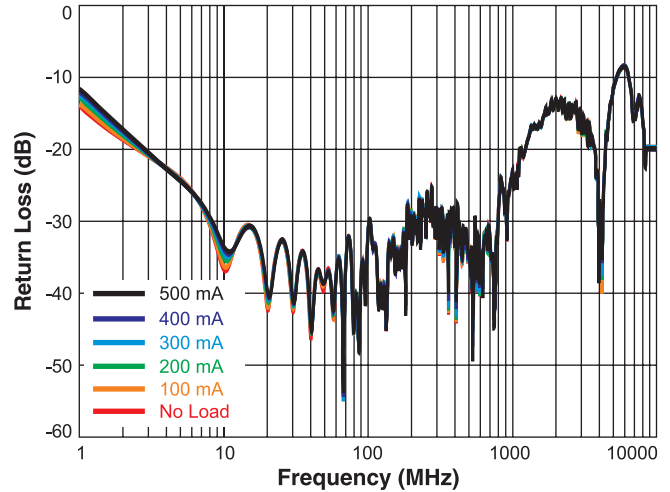

Insertion Loss (2 m cable)

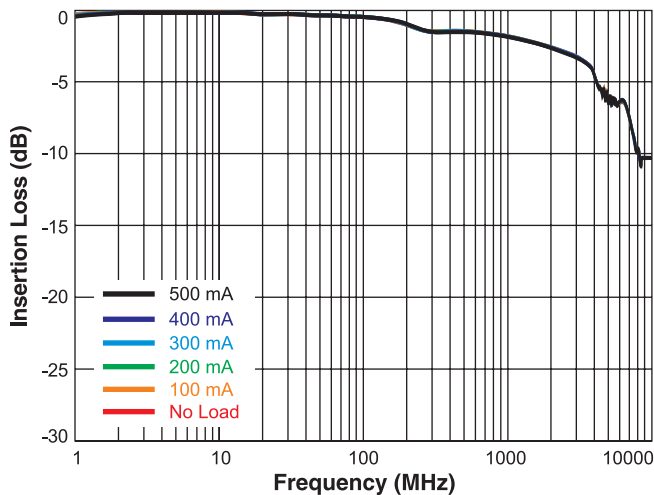

Insertion Loss (10 m cable)

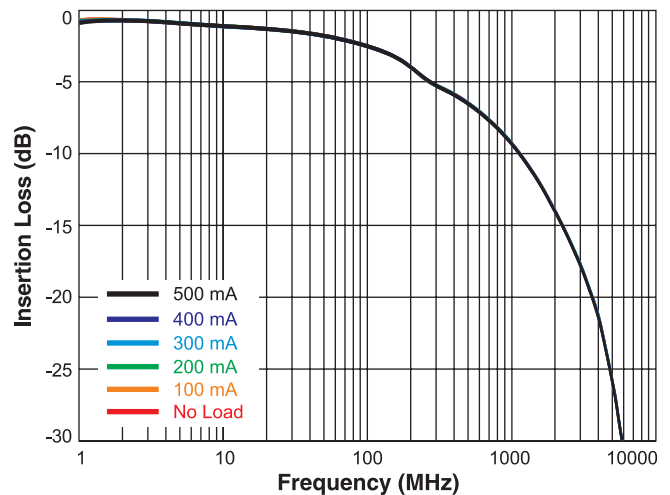

PoC Filter Solution – SMD-POC-032

S-Parameters (300 mA, 2 m cable at temperature)

