

NEW!

Shielded Power Inductors – SLR1075

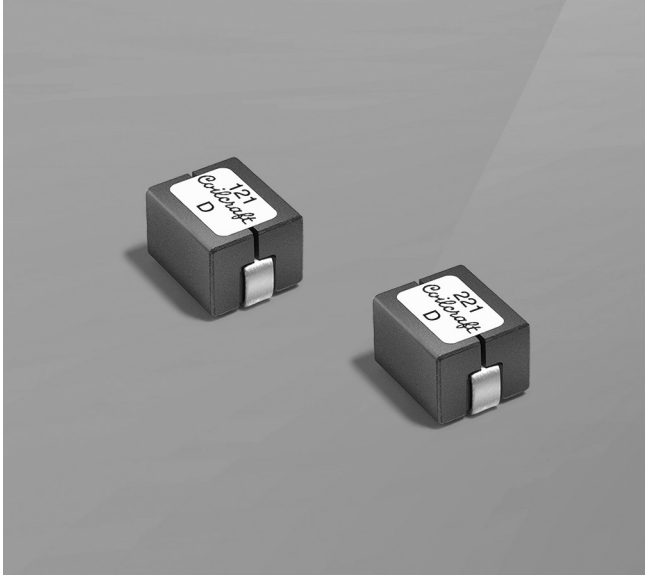

- Tight DCR tolerance for inductor-DCR-based current sensing circuits
- Excellent current handling, up to 93 A
- 10.4 × 8.0 × 7.4 mm surface mount package
- Designed for use in multi-phase VRM/VRD/EVRD regulators

Designer's Kit C467 contains 3 each of select values.

Core material Ferrite

Weight 3.5 – 3.6 g

Environmental RoHS compliant, halogen free

Terminations RoHS compliant matte tin over nickel over copper.

Ambient temperature –40°C to +85°C with (40°C rise) Irms current.

Maximum part temperature +125°C (ambient + temp rise).

Storage temperature Component: –40°C to +125°C.

Tape and reel packaging: –40°C to +80°C

Resistance to soldering heat Max three 40 second reflows at

+260°C, parts cooled to room temperature between cycles

Moisture Sensitivity Level (MSL) 1 (unlimited floor life at <30°C / 85% relative humidity)

Failures in Time (FIT) / Mean Time Between Failures (MTBF)

38 per billion hours / 26,315,789 hours, calculated per Telcordia SR-332

Packaging 100/7" reel; 500/13" reel; Plastic tape: 24 mm wide, 0.4 mm thick, 12 mm pocket spacing, 7.75 mm pocket depth

PCB washing Tested to MIL-STD-202 Method 215 plus an additional aqueous wash. See [Doc787_PCB_Washing.pdf](#).

Part number ¹	Inductance ² ±10% (nH)	DCR ±7% ³ (mOhms)	SRF typ (MHz)	Isat (A) ⁴			Irms (A) ⁵	
				at 25°C	at 100°C	at 125°C	20°C rise	40°C rise
SLR1075-121KE_	120	0.29	59	93.0	78.5	72.0	50	67
SLR1075-151KE_	150	0.29	48	72.0	59.0	54.0	50	67
SLR1075-171KE_	170	0.29	44	65.0	51.5	48.0	50	67
SLR1075-221KE_	215	0.29	36	53.0	40.0	37.0	50	67
SLR1075-231KE_	230	0.29	35	49.0	36.5	33.5	50	67
SLR1075-271KE_	270	0.29	30	41.0	32.0	29.5	50	67
SLR1075-301KE_	300	0.29	27	36.0	26.5	24.0	50	67

1. When ordering, please specify **packaging** code:

SLR1075-301KEC

Packaging: **C** = 7" machine-ready reel. EIA-481 embossed plastic tape (100 parts per full reel).

B = Less than full reel. In tape, but not machine ready. To have a leader and trailer added (\$25 charge), use code letter C instead.

D = 13" machine-ready reel. EIA-481 embossed plastic tape. Factory order only, not stocked (500 parts per full reel).

2. Inductance at 100 kHz, 0.1 Vrms, 0 Adc.

3. DCR is measured on a micro-ohmmeter at points indicated in the diagram below.



4. DC current that causes an inductance drop of 20% (typ) from its value without current.

5. Current that causes the specified temperature rise from 25°C ambient. This information is for reference only and does not represent absolute maximum ratings.

6. Electrical specifications at 25°C.

Refer to Doc 362 "Soldering Surface Mount Components" before soldering.

Irms Testing

Irms testing was performed on 0.75 inch wide × 0.25 inch thick copper traces in still air.

Temperature rise is highly dependent on many factors including pcb land pattern, trace size, and proximity to other components. Therefore temperature rise should be verified in application conditions.



www.coilcraft.com

US +1-847-639-6400 sales@coilcraft.com

UK +44-1236-730595 sales@coilcraft-europe.com

Taiwan +886-2-2264 3646 sales@coilcraft.com.tw

China +86-21-6218 8074 sales@coilcraft.com.cn

Singapore + 65-6484 8412 sales@coilcraft.com.sg

Document 1306-1 Revised 05/31/16

© Coilcraft Inc. 2016

This product may not be used in medical or high risk applications without prior Coilcraft approval. Specification subject to change without notice. Please check web site for latest information.

NEW!

SLR1075 Shielded Power Inductors

L vs Frequency

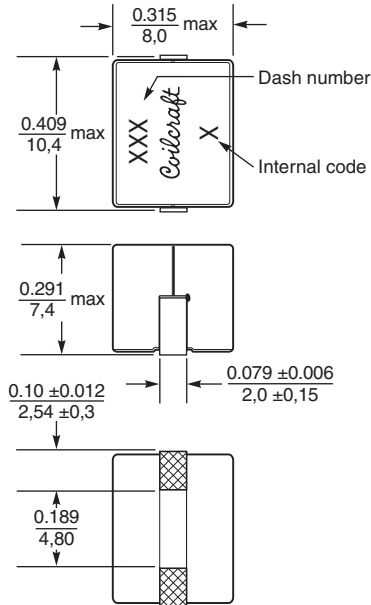
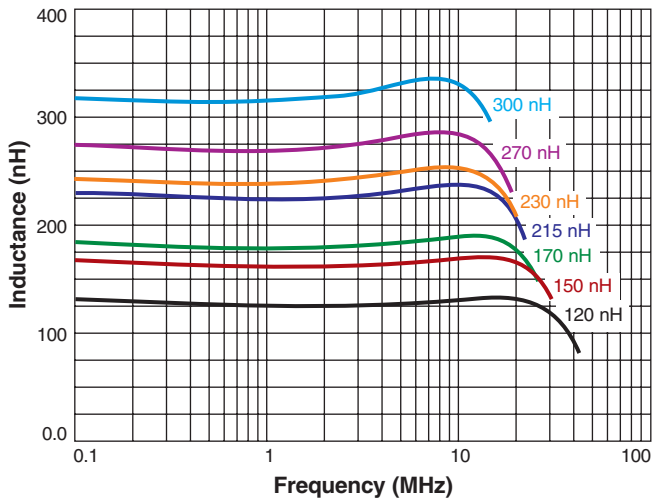

Dimensions are in $\frac{\text{inches}}{\text{mm}}$

Recommended Land Pattern

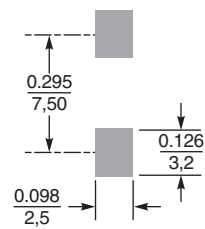

NEW!

SLR1075 Shielded Power Inductors

L vs Current

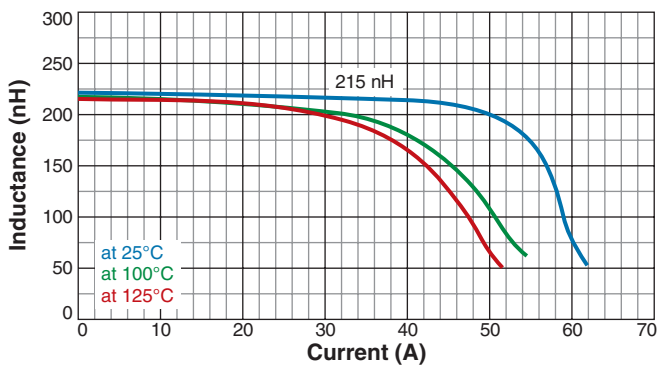
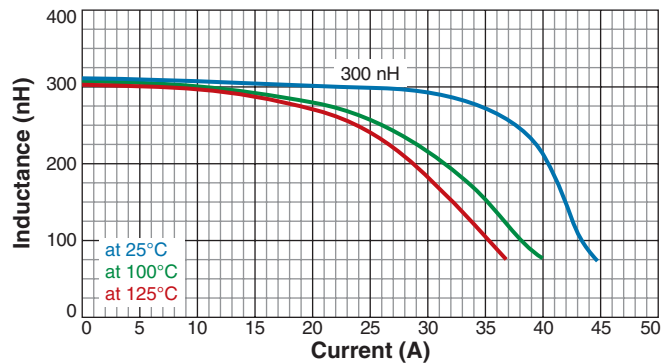
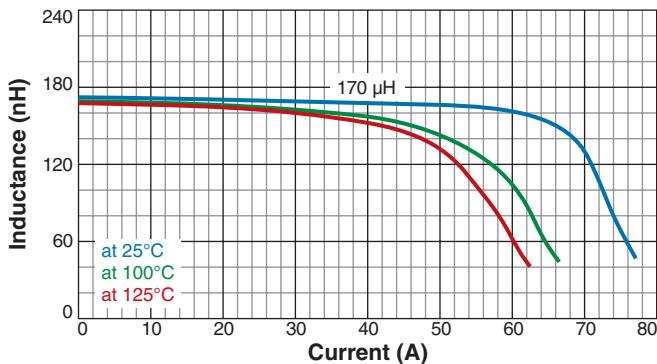
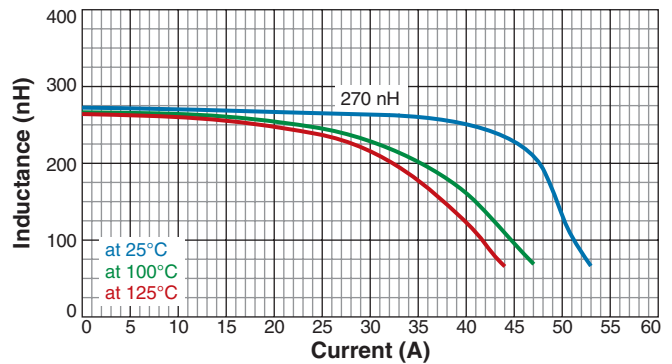
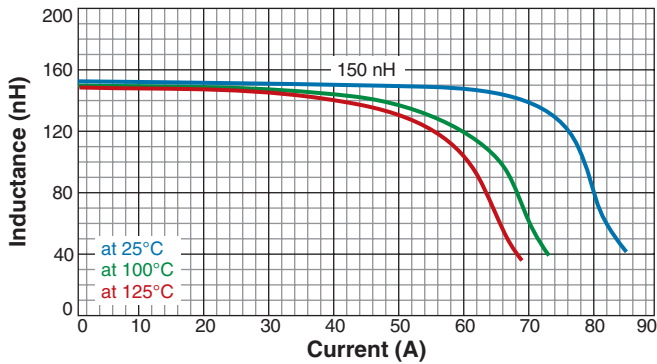
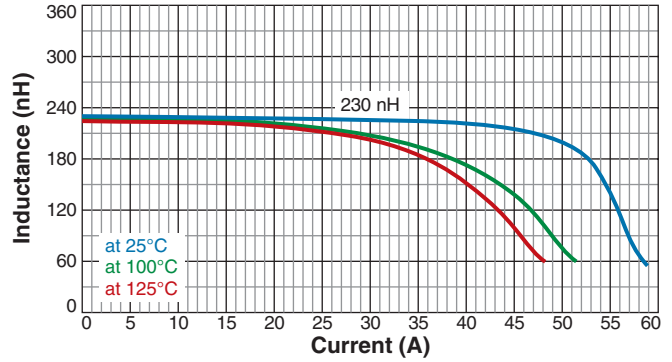
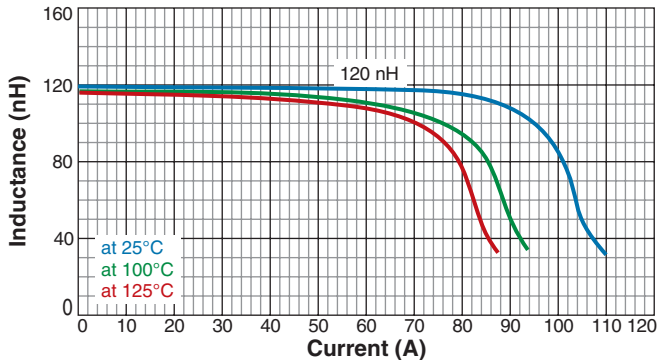

US +1-847-639-6400 sales@coilcraft.com
UK +44-1236-730595 sales@coilcraft-europe.com
Taiwan +886-2-2264 3646 sales@coilcraft.com.tw
China +86-21-6218 8074 sales@coilcraft.com.cn
Singapore + 65-6484 8412 sales@coilcraft.com.sg

Document 1306-3 Revised 05/31/16
 © Coilcraft Inc. 2016
 This product may not be used in medical or high risk applications without prior Coilcraft approval. Specification subject to change without notice. Please check web site for latest information.