

**NEW!**

# Power Injection Chokes for PoC 1210POCA



- Small size to minimize the board area of overall system solutions, with a low profile of only 2.5 mm
- High impedance ( $\geq 1\text{k}\Omega$ ) maintained over a wide band frequency range to isolate AC signal from the DC power
- AEC-Q200 qualified

**Core material** Ferrite

**Environmental** RoHS compliant, halogen free

**Terminations** RoHS compliant matte tin over nickel over silver-platinum-glass frit.

**Weight** 115 – 125 mg

**Ambient temperature**  $-40^{\circ}\text{C}$  to  $+125^{\circ}\text{C}$  with  $I_{\text{rms}}$  current.

**Maximum part temperature**  $+140^{\circ}\text{C}$  (ambient + temp rise).

**Storage temperature** Component:  $-40^{\circ}\text{C}$  to  $+140^{\circ}\text{C}$ .  
Tape and reel packaging:  $-40^{\circ}\text{C}$  to  $+80^{\circ}\text{C}$

**Resistance to soldering heat** Max three 40 second reflows at  $+260^{\circ}\text{C}$ , parts cooled to room temperature between cycles

**Moisture Sensitivity Level (MSL)** 1 (unlimited floor life at  $<30^{\circ}\text{C}$  / 85% relative humidity)

**Packaging** 750/7" reel; 3000/13" reel; Plastic tape: 12 mm wide, 0.25 mm thick, 8 mm pocket spacing, 2.72 mm pocket depth

**PCB washing** Tested to MIL-STD-202 Method 215 plus an additional aqueous wash. See [Doc787\\_PCB\\_Washing.pdf](#).

Part number <sup>1</sup>	$L^2$ $\pm 20\%$ ( $\mu\text{H}$ )	DCR (Ohms) <sup>3</sup>		SRF typ <sup>4</sup> (MHz)	Isat (mA) <sup>5</sup>					I <sub>rms</sub> typ (mA)		
		typ	max		25°C	85°C	105°C	125°C	140°C	at 25°C <sup>6</sup>	at 85°C <sup>7</sup>	at 125°C <sup>8</sup>
1210POCA-222MR_	2.2	0.12	0.144	300	1800	1600	1400	1300	1100	1900	1800	800
1210POCA-682MR_	6.8	0.20	0.24	120	1100	900	850	740	640	1300	1200	700
1210POCA-103MR_	10	0.25	0.30	90	870	720	650	600	550	1200	1100	630
1210POCA-153MR_	15	0.40	0.48	80	750	650	570	500	450	960	870	500
1210POCA-223MR_	22	0.85	0.97	70	600	530	470	420	350	660	600	330

1. When ordering, please specify **packaging** code:

**1210POCA-223MRC**

**Packaging:** **C** = 7" machine-ready reel. EIA-481 embossed plastic tape (750 parts per full reel). Quantities less than full reel available: in tape (not machine ready) or with leader and trailer (\$25 charge).

**D** = 13" machine-ready reel. EIA-481 embossed plastic tape (3000 parts per full reel). Factory order only, not stocked.

- Inductance tested at 100 kHz, 0.1 Vrms, 200 mA using HP4263 with SMD-B test fixture or equivalent
- DCR is measured on a Keithley 580 Micro-ohmmeter (or equivalent) with a Coilcraft CCF858 or CCF 987 test fixture.
- SRF measured using an Agilent/HP 5071C network analyzer and a Coilcraft SMD-D test fixture.
- DC current that causes 30% inductance drop from its initial value at 200 mA at specified temperature.
- Current that causes a 40°C rise at 25°C.
- Current that causes a 40°C rise at 85°C.
- Current that causes a 15°C rise at 125°C.
- Electrical specifications at 25°C.

Refer to Doc 362 "Soldering Surface Mount Components" before soldering.

## Dimensions – 1210POCA

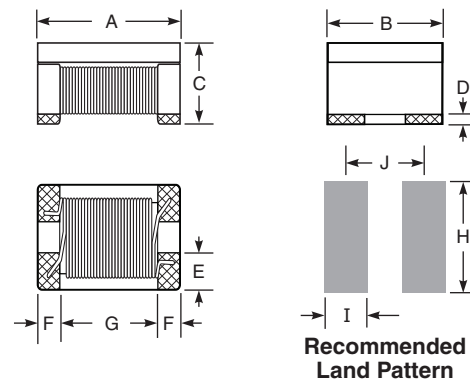

**Recommended Land Pattern**

A	B	C	D	E	F	G	H	I	J	
max	max	max								
0.13	0.105	0.098	0.004	0.037	0.020	0.080	0.104	0.026	0.100	in
3,30	2,67	2,50	0,10	0,94	0,51	2,03	2,65	0,65	2,54	mm



# 1210POCA Power Injection Chokes for PoC

## L vs Current

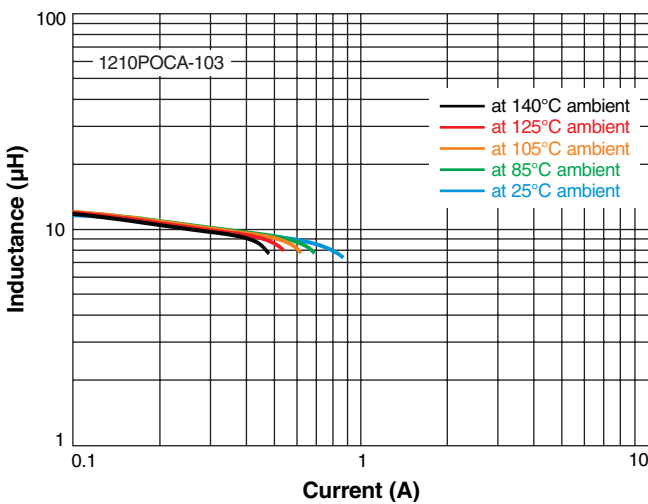
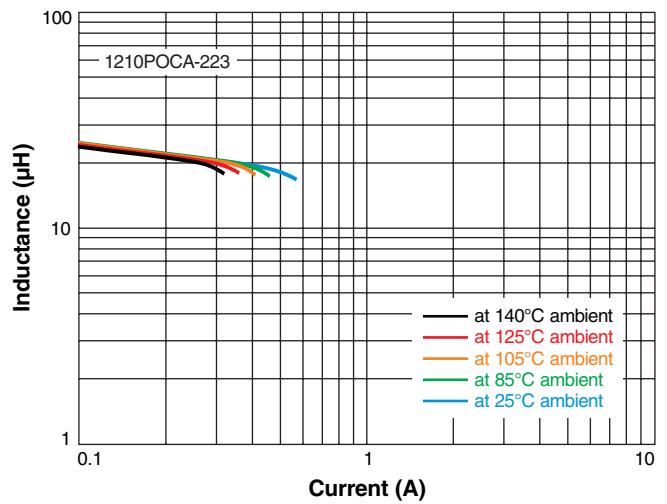
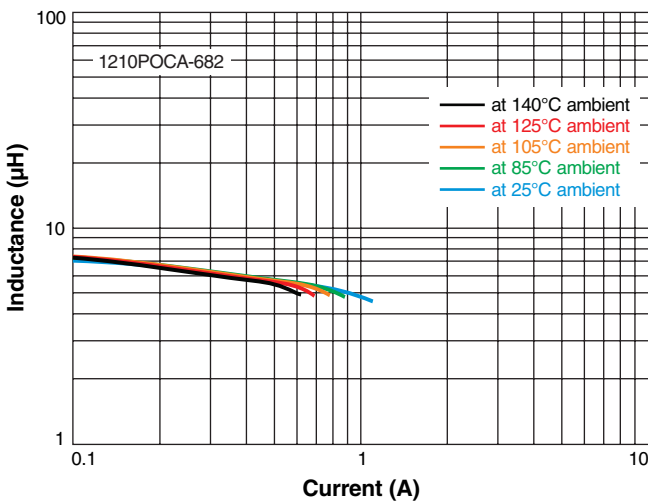
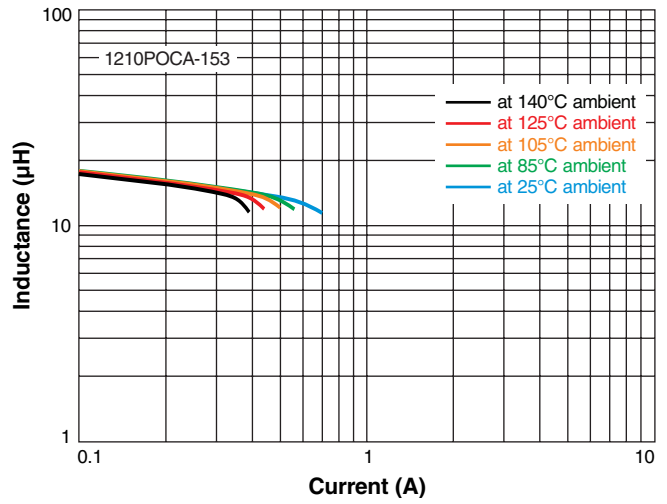
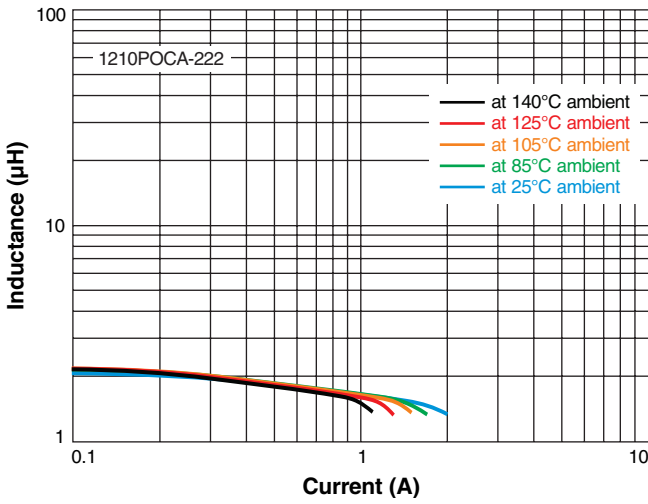

**US** +1-847-639-6400 sales@coilcraft.com  
**UK** +44-1236-730595 sales@coilcraft-europe.com  
**Taiwan** +886-2-2264 3646 sales@coilcraft.com.tw  
**China** +86-21-6218 8074 sales@coilcraft.com.cn  
**Singapore** + 65-6484 8412 sales@coilcraft.com.sg

Document 1768-2 Revised 07/18/24  
 © Coilcraft Inc. 2024  
 This product may not be used in medical or high risk applications without prior Coilcraft approval. Specification subject to change without notice. Please check web site for latest information.



# 1210POCA Power Injection Chokes for PoC

## Impedance vs Frequency

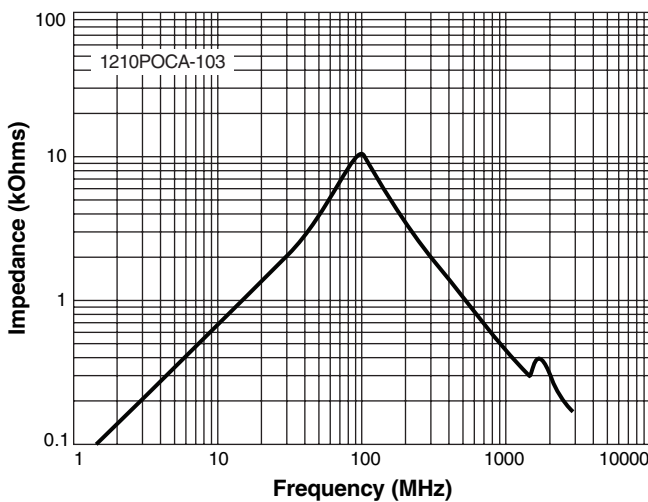
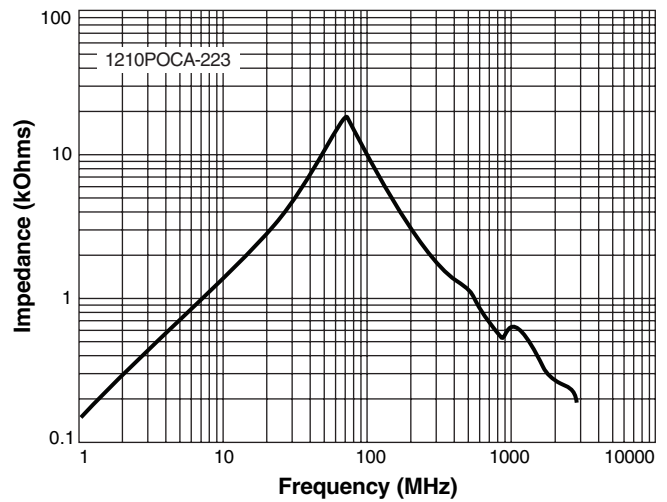
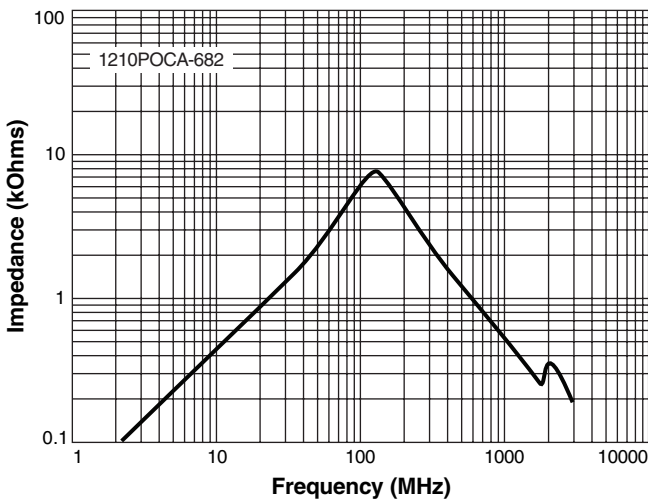
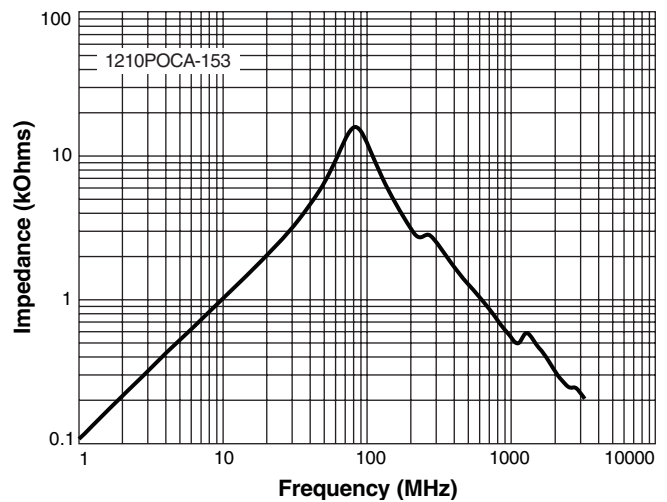
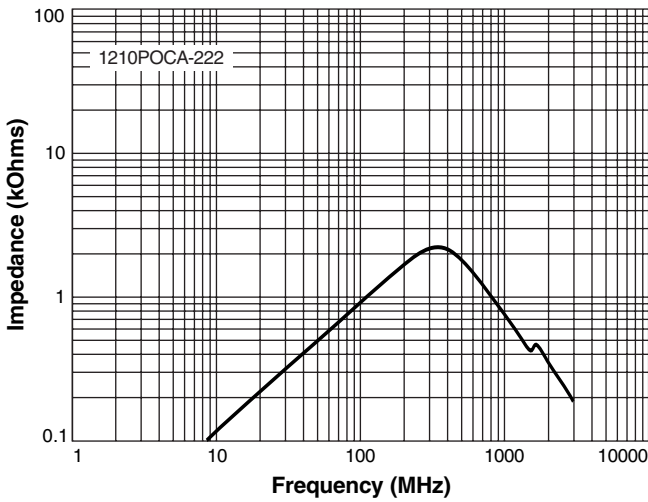

**US** +1-847-639-6400 sales@coilcraft.com  
**UK** +44-1236-730595 sales@coilcraft-europe.com  
**Taiwan** +886-2-2264 3646 sales@coilcraft.com.tw  
**China** +86-21-6218 8074 sales@coilcraft.com.cn  
**Singapore** + 65-6484 8412 sales@coilcraft.com.sg

Document 1768-3 Revised 07/18/24  
 © Coilcraft Inc. 2024  
 This product may not be used in medical or high risk applications without prior Coilcraft approval. Specification subject to change without notice. Please check web site for latest information.