

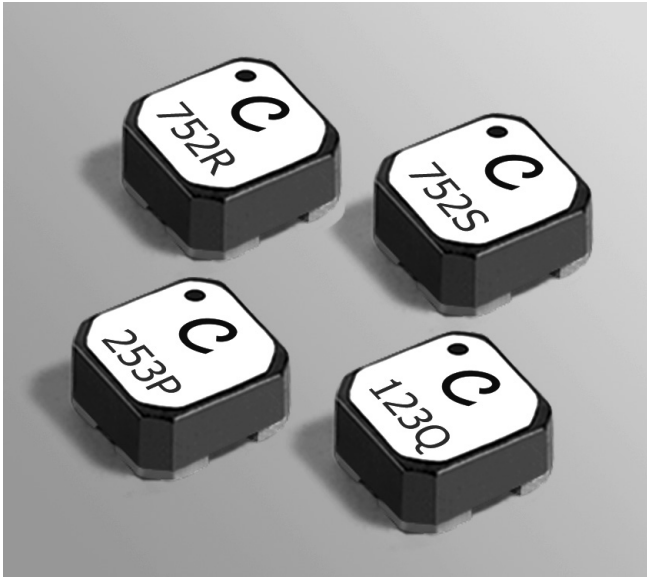

Coupled Inductors - LPR6235

For Step-Up, Resonant & Flyback Applications



- Can be used as step-up or flyback transformers in DC-DC converters or as autotransformers
- Perfect for low voltage step-up in energy harvesting applications
- Selected by Linear Technology for the LTC3108 and LTC3109 Ultralow Voltage Step-Up Converter and Power Managers
- 300 Vrms, one minute isolation (hipot) between windings
- 3.5 mm high and 6 mm square
- Excellent coupling coefficient ($k = 0.95$); ideal for use in a variety of applications such as flyback transformers and step-up pulse transformers.
- High Isat and low DCR ratings provide high efficiency and excellent current handling in a rugged, low cost design
- Custom inductance values and turn ratios are available upon request

Part number ¹	Turns ratio	Primary (L1) inductance ² ±20% (μH)	DCR max (Ohms)		SRF typ ³ (kHz)	Isat ⁴ (A)
			L1	L2		
LPR6235-253LMR_	1 : 10	25	0.74	13.7	1300	1.3
LPR6235-253PMR_	1 : 20	25	0.20	72	580	0.7
LPR6235-123QMR_	1 : 50	12.5	0.085	200	360	0.9
LPR6235-752RMR_	1 : 90	7.5	0.085	285	257	1.6
LPR6235-752SMR_	1 : 100	7.5	0.085	340	230	1.6

1. When ordering, please specify **packaging** code:

LPR6235-253PMRC

Packaging: C = 7" machine-ready reel. EIA-481 embossed plastic tape (350 parts per full reel). Quantities less than full reel available: in tape (not machine ready) or with leader and trailer (\$25 charge).

B = In an effort to simplify our part numbering system, Coilcraft is eliminating the need for multiple packaging codes. When ordering, simply change the last letter of your part number from B to C.

D = 13" machine-ready reel. EIA-481 embossed plastic tape. Factory order only, not stocked (1500 parts per full reel).

2. Inductance is measured at 100 kHz, 0.1 Vrms, 0 Adc for -253LMR. All other values are measured at 10 kHz, 0.1 Vrms, 0 Adc on an Agilent/HP 4284A LCR meter or equivalent.

3. SRF measured using an Agilent/HP 4191A or equivalent.

4. DC current applied to L1, at which the inductance drops 10% from its value without current.

5. Electrical specifications at 25°C.

Refer to Doc 362 "Soldering Surface Mount Components" before soldering.

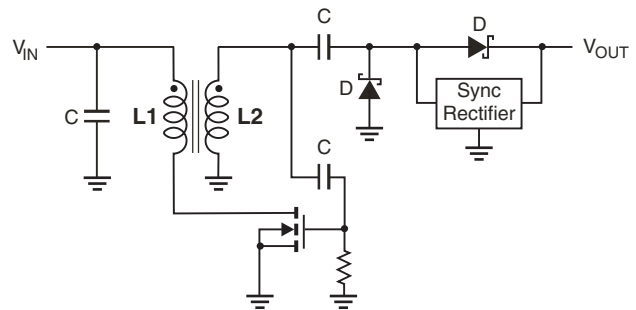

Typical Step-Up Converter

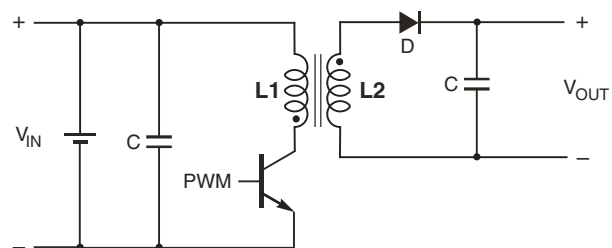

Typical Flyback Converter



www.coilcraft.com

US +1-847-639-6400 sales@coilcraft.com
UK +44-1236-730595 sales@coilcraft-europe.com
Taiwan +886-2-2264 3646 sales@coilcraft.com.tw
China +86-21-6218 8074 sales@coilcraft.com.cn
Singapore + 65-6484 8412 sales@coilcraft.com.sg

Document 752R-1 Revised 12/04/20

© Coilcraft Inc. 2020

This product may not be used in medical or high risk applications without prior Coilcraft approval. Specification subject to change without notice. Please check web site for latest information.



Step-Up/Flyback Transformers – LPR6235

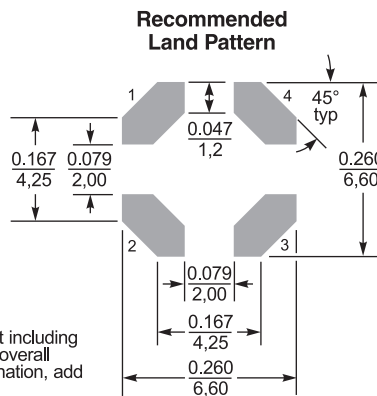
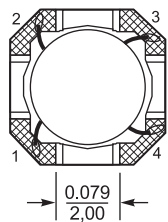
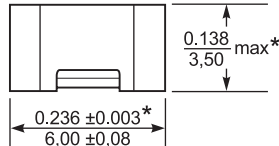
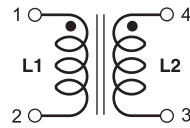
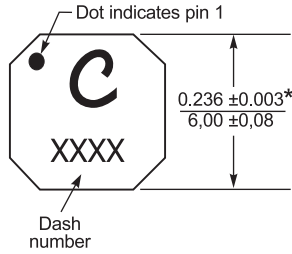

* Dimensions are of the case not including the termination. For maximum overall dimensions including the termination, add 0.005 in / 0,13 mm.

For optional tin-lead and tin-silver-copper terminations, dimensions are for the mounted part. Dimensions before mounting can be an additional 0.005 inch / 0,13 mm).

Dimensions are in $\frac{\text{inches}}{\text{mm}}$

Core material Ferrite

Weight 460 – 480 mg

Environmental RoHS compliant, halogen free

Terminations RoHS compliant matte tin over nickel over silver. Other terminations available at additional cost.

Ambient temperature –40°C to +85°C

Storage temperature Component: –40°C to +125°C.

Tape and reel packaging: –40°C to +80°C

Winding to winding isolation 300 Vrms

Resistance to soldering heat Max three 40 second reflows at +260°C, parts cooled to room temperature between cycles

Moisture Sensitivity Level (MSL) 1 (unlimited floor life at <30°C / 85% relative humidity)

Mean Time Between Failures (MTBF) 26,315,789 hours

Failures in Time (FIT) 38 per one billion hours

Packaging 350/7" reel; 1500/13" reel Plastic tape: 16 mm wide, 0.3 mm thick, 12 mm pocket spacing, 3.68 mm pocket depth

Recommended pick and place nozzle OD: 6.2 mm; ID: ≤ 3.1 mm

PCB washing Tested to MIL-STD-202 Method 215 plus an additional aqueous wash. See [Doc787_PCB_Washing.pdf](#).