

Base/Gate Driver Transformers

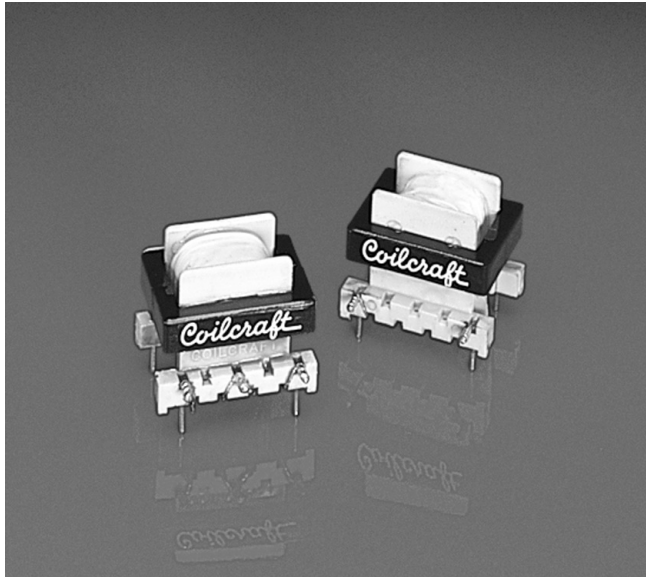

- Lower cost than toroidal equivalents
- Frequency range of 10 – 250 kHz and up
- Industry standard pin centers
- 3750 Vrms, one minute isolation (hipot) between primary and secondary windings; 1500 Vrms, one minute between secondaries
- UL1446 Class B (130°C) Insulation System (UL File E83628)

Coilcraft **Designer's Kit No. P404** contains samples of four standard driver transformers. To order, contact Coilcraft or visit <http://order.coilcraft.com> to purchase on-line.

	SD250-1L	SD250-2L	SD250-3L	SD250-4L
Turns ratio $\pm 3\%$ (pri:sec)	1 : 1	1 : 1.5	1 : 1 : 1	1 : 1.5 : 1.5
Primary winding				
Inductance (min) ¹	1.5 mH	1.5 mH	1.5 mH	1.5 mH
Leakage inductance (max) ¹	4.0 μ H	4.0 μ H	4.0 μ H	4.0 μ H
DCR	0.4 Ω	0.4 Ω	0.4 Ω	0.4 Ω
Volt-time product	375 V- μ sec	375 V- μ sec	375 V- μ sec	375 V- μ sec
Secondary winding(s)				
Capacitance, pri to sec (max)	50 pF	50 pF	50 pF	50 pF
DCR, each section (max)	0.75 Ω	2.5 Ω	0.75 Ω	2.5 Ω

SD250-1 and 250-2

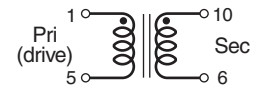

SD250-3 and 250-4

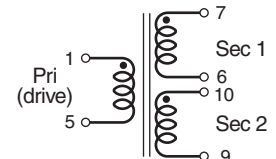

1. Measured at 1 Vrms, 15.75 kHz.
2. Operating temperature range -40°C to $+85^{\circ}\text{C}$.
3. Electrical specifications at 25°C .

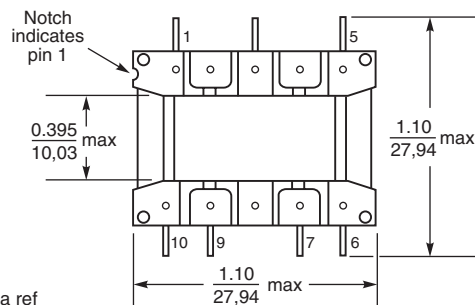
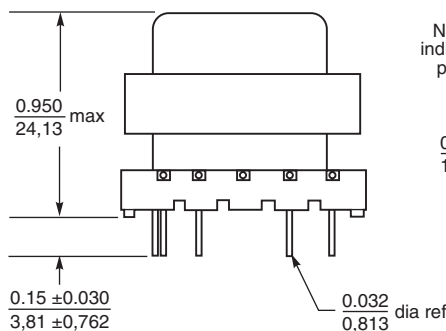

Recommended board layout

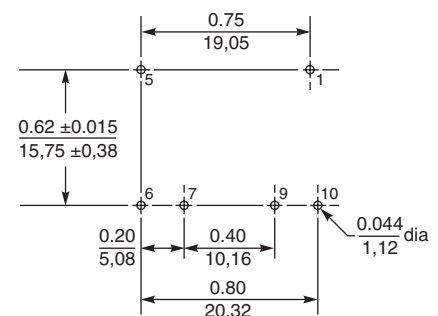

Pins 7 and 9 are not present on SD250-1 and SD250-2

Weight: 15.6 – 16.8 g
Termination: Tin-silver over tin over copper
Packaging: 49 per tray



www.coilcraft.com

US +1-847-639-6400 sales@coilcraft.com
UK +44-1236-730595 sales@coilcraft-europe.com
Taiwan +886-2-2264 3646 sales@coilcraft.com.tw
China +86-21-6218 8074 sales@coilcraft.com.cn
Singapore + 65-6484 8412 sales@coilcraft.com.sg

Document 130-1 Revised 04/20/12

© Coilcraft Inc. 2015

This product may not be used in medical or high risk applications without prior Coilcraft approval. Specification subject to change without notice. Please check web site for latest information.



Custom Version Specifications

In addition to the standard base/gate driver transformers shown here, Coilcraft can provide custom versions to meet your specifications.

Our two basic structures are the 0.95" high part shown and a 1.20" high version. Both are available with either single or double sections.

Volt-Time vs Primary Turns*

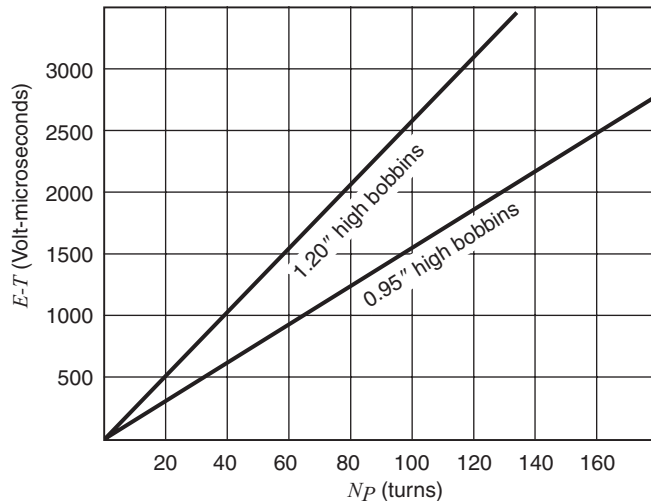

* Applies to both double and single section bobbins.

Turns Per Layer vs Wire Size*

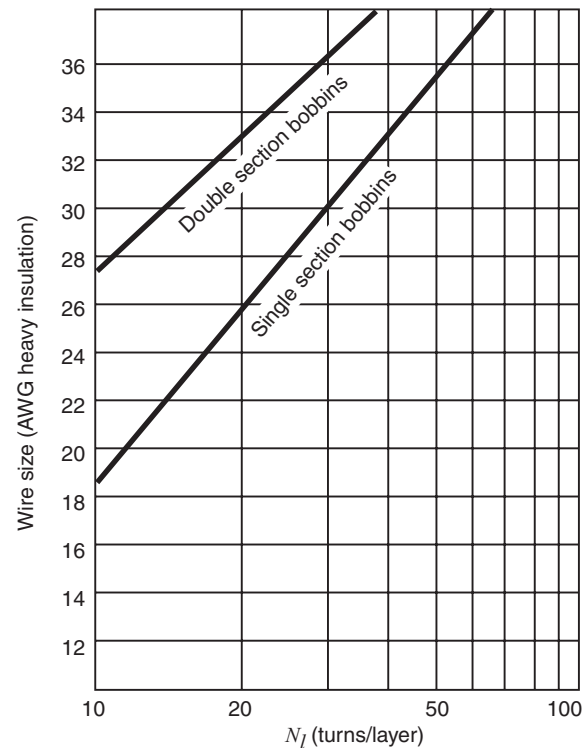

* Applies to both 0.95" and 1.20" high bobbins.

Please use the information below to determine the performance characteristics available.

Core

	<u>0.95" high bobbins</u>	<u>1.20" high bobbins</u>
Initial permeability	2000 μ	2000 μ
A_e (core cross-sectional area)	0.40 cm ²	0.80 cm ²
l_e (mean magnetic path length)	4.90 cm	4.80 cm

Bobbin

	UL94V-0, 130°C	
Material		
Number of terminals available	10	10
Number of wiring sections available	1 or 2	1 or 2



www.coilcraft.com

US +1-847-639-6400 sales@coilcraft.com
UK +44-1236-730595 sales@coilcraft-europe.com
Taiwan +886-2-2264 3646 sales@coilcraft.com.tw
China +86-21-6218 8074 sales@coilcraft.com.cn
Singapore + 65-6484 8412 sales@coilcraft.com.sg

Document 130-2 Revised 04/20/12

© Coilcraft Inc. 2015

This product may not be used in medical or high risk applications without prior Coilcraft approval. Specification subject to change without notice. Please check web site for latest information.