

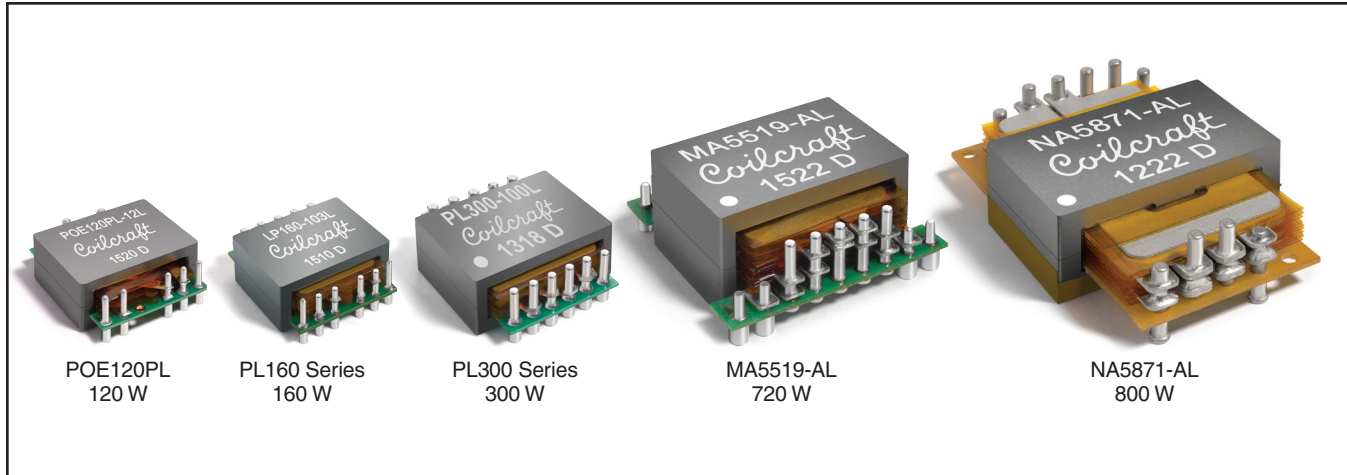

Planar Transformers



- Low profile power transformers
- Very high efficiency; low DCR
- Can be used in a wide range of topologies
- 1500 Vrms, one minute isolation (hipot) between windings
- Power range: 120 – 800 Watts
- Frequency range up to 700 kHz

Planar transformers are an ideal solution for high frequency switch mode power converters. They offer higher power density and higher current handling capability in a lower profile compared with traditional wire wound transformers.

A new planar transformer design, constructed with flat coil windings and copper plates rather than multi-layer PCBs, increases the power level (up to 800 W) and lowers the leakage inductance. This design exceeds the critical electrical requirement for topologies such as push pull, half bridge, or full bridge. The POE120PL, PL160, PL300, MA5519-AL, and NA5871-AL are new generation planar transformers offering efficiency up to 98%.

Coilcraft custom designed planar transformers are used in a wide variety of IC reference designs, as shown on page 6. For applications not covered in the table, custom designs are available on request.

POE120PL

- Designed for active clamp forward topology
- Operates at 200 kHz, with 36 – 72 Volt input
- Provides 0.009" (0.229 mm) clearance above the seating plane
- Includes a 12-Volt auxiliary winding

PL160

- Designed to operate between 200 kHz and 700 kHz with a nominal 48 V input.
- Provides 0.009" (0.229 mm) clearance above the seating plane
- May be special ordered with an auxiliary winding

PL300

- Designed to operate between 200 kHz and 700 kHz with a nominal 48 V input.
- Provides 0.009" (0.229 mm) clearance above the seating plane
- May be special ordered with an auxiliary winding

MA5519-AL

- Developed for Texas Instruments PMP9219 LM5045 based 720 W Power Converter
- Provides 0.009" (0.229 mm) clearance above the seating plane
- Designed to operate at 400 kHz with 36 – 75 V input
- 12 V, 60 A output
- Listed as T2 on Texas Instruments BOM-PMP9219

NA5871-AL

- Developed for Texas Instruments PMP6712 Dual-Channel 800 Watt Full-Bridge Converter for PoE Power Sourcing (PSE)
- Designed to operate at 400 kHz with 38 – 60 V input
- 54 V, 15 A output
- Listed as T2 and T4 on Texas Instruments BOM-PMP6712
- Insulated bottom surface



www.coilcraft.com

US +1-847-639-6400 sales@coilcraft.com
UK +44-1236-730595 sales@coilcraft-europe.com
Taiwan +886-2-2264 3646 sales@coilcraft.com.tw
China +86-21-6218 8074 sales@coilcraft.com.cn
Singapore + 65-6484 8412 sales@coilcraft.com.sg

Document 1280-1 Revised 11/16/15

© Coilcraft Inc. 2017

This product may not be used in medical or high risk applications without prior Coilcraft approval. Specification subject to change without notice. Please check web site for latest information.



Planar Transformers

Power (W)	Part number ¹	Turns			Inductance ² (μH)	Leakage Inductance ³ (μH)	DCR max ⁴ (mOhms)			Volt-time product ⁵ (V-μsec)	Schematic
		Pri ₁	Pri ₂	Sec			Pri ₁	Pri ₂	Sec		
120	POE120PL-33L_	12	—	2	50	0.7	27.6	—	1.26	150	B
120	POE120PL-50L_	8	—	2	50	0.31	18.9	—	1.26	100	B
120	POE120PL-12L_	8	—	4	50	0.37	18.9	—	6.8	100	B
120	POE120PL-24L_	8	—	8	50	0.39	18.9	—	13.6	100	B
160	PL160-100L	4	4	4	153	0.35	14.7	14.7	6.8	150	A
160	PL160-101L	4	5	4	194	0.40	14.7	18.5	6.8	168	A
160	PL160-102L	5	5	4	240	0.45	18.5	18.5	6.8	187	A
160	PL160-103L	5	6	4	290	0.55	18.5	21.5	6.8	206	A
160	PL160-104L	6	6	4	345	0.55	21.5	21.5	6.8	224	A
300	PL300-100L	4	4	4	211	0.25	7.2	7.2	4.2	206	A
300	PL300-101L	5	5	4	330	0.35	9.0	9.0	4.2	258	A
300	PL300-102L	6	6	4	423	0.50	10.6	10.6	4.2	310	A
300	PL300-103L	7	7	4	588	0.75	12.3	12.3	4.2	361	A
300	PL300-104L	8	8	4	768	1.0	13.8	13.8	4.2	413	A
720	MA5519-AL	6	—	4	190.8	0.13	5.0	—	1.53	197	C
800	NA5871-AL	3	—	5	42	0.20	1.37	—	4.4	117	D

1. When ordering the POE120PL or the PL160, specify **packaging** code:

POE120PL-24LD

Packaging: Blank In trays, 36 per tray

D = Optional tape and reel (additional cost), 13" machine-ready reel. EIA-481 embossed plastic tape. See tape and reel specifications on page 2.

B = Optional tape and reel (additional cost), less than full reel. In tape, but not machine ready. To have a leader and trailer added (\$25 charge), use code letter D instead.

To order a PL160 or PL300 with an optional **auxiliary winding**, add an "X" and the turn count after the PL160 (PL300), e.g. PL160X3-100LB. Turn counts of 2, 3, 4, 5, 7 and 9 are available for the auxiliary winding. Parts with auxiliary windings are not stocked.

- Inductance measured on an Agilent/HP 4284 at 200 kHz, 0.5 Vrms, 0 Adc between pins 2 and 5 with pins 3 and 4 connected.
 - Leakage inductance is for the primary connected in series with all secondary pins shorted.
 - DCR is measured across all windings.
 - Volt-time product is based on the entire primary winding and 3000 Gauss.
 - Electrical specifications at 25°C.
- Refer to Doc 362 "Soldering Surface Mount Components" before soldering.

Core material Ferrite

Terminations Matte tin over nickel over brass.

Ambient temperature -40°C to +120°C

Storage temperature Component: -40°C to +125°C.

Tray and tape and reel packaging: -40°C to +80°C

Resistance to soldering heat Max three 40 second reflows at +260°C, parts cooled to room temperature between cycles

Moisture Sensitivity Level (MSL) 1 (unlimited floor life at <30°C / 85% relative humidity)

Failures in Time (FIT) / Mean Time Between Failures (MTBF)

38 per billion hours / 26,315,789 hours, calculated per Telcordia SR-332

PCB washing Tested to MIL-STD-202 Method 215 plus an additional aqueous wash. See [Doc787_PCB_Washing.pdf](#).

Schematics

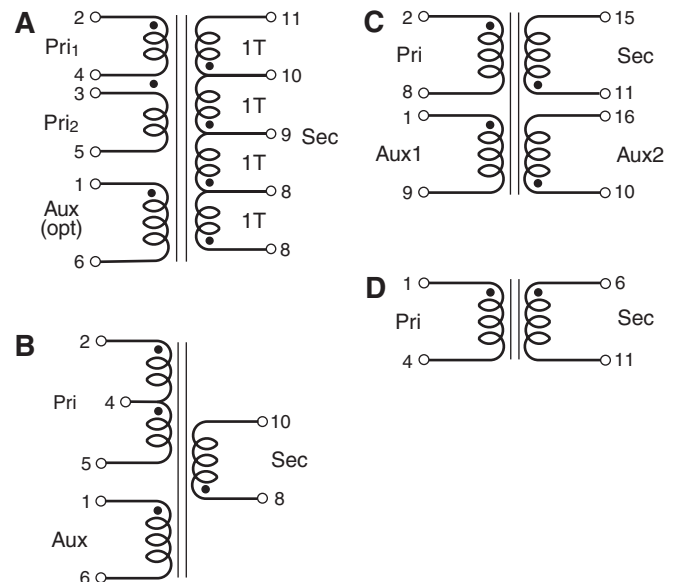



Planar Transformers

Calculating Efficiency

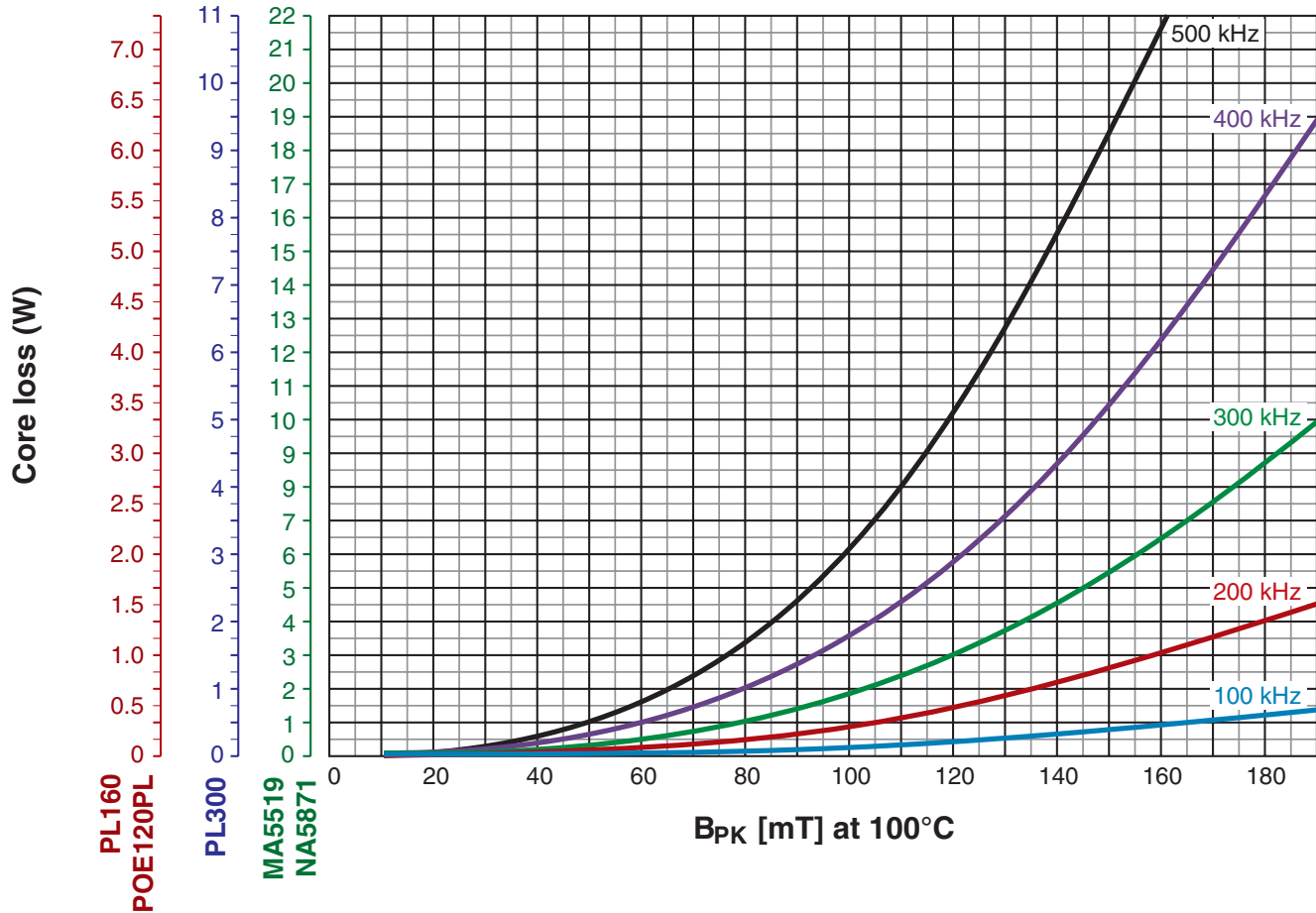

This graph represents core loss versus flux density for each series. By determining core loss and copper loss, the overall efficiency can be estimated.

$$\text{Efficiency (\%)} = (P_{\text{OUT}} - (\text{CORE_loss} + \text{COPPER_loss}) / P_{\text{OUT}}) \times 100$$

where $P_{\text{OUT}} = \text{desired } V \times I$

Core loss is a function of core material, flux density swing ($\Delta B = 2 \times B_{\text{PK}}$), frequency, and core size. Use the following equation for calculating peak flux density (B_{PK}) and then read CORE_loss from Y-axis on the graph.

$$B_{\text{PK}} = K \times V_{\text{in}} \times D_{\text{max}} / (\text{Freq} \times N)$$

Where:

- K = series factor (see table)
- V_{in} = primary DC voltage
- D_{max} = maximum duty cycle
- Freq = switching frequency in kHz
- N = number of primary turns

Part/Series number	K factor
POE120PL	80×10^2
PL160	80×10^2
PL300	58×10^2
MA5519	45.5×10^2
NA5871	38.5×10^2

Copper loss is a function of I_{rms} and DC resistance of each winding. Use the following equation for calculating copper loss.

$$\text{COPPER_loss} = I_{\text{rms}}(\text{pri})^2 \times \text{DCR}(\text{pri}) + I_{\text{rms}}(\text{sec})^2 \times \text{DCR}(\text{sec})$$



US +1-847-639-6400 sales@coilcraft.com
UK +44-1236-730595 sales@coilcraft-europe.com
Taiwan +886-2-2264 3646 sales@coilcraft.com.tw
China +86-21-6218 8074 sales@coilcraft.com.cn
Singapore + 65-6484 8412 sales@coilcraft.com.sg

Document 1280-3 Revised 11/16/15
 © Coilcraft Inc. 2017
 This product may not be used in medical or high risk applications without prior Coilcraft approval. Specification subject to change without notice. Please check web site for latest information.



Planar Transformers

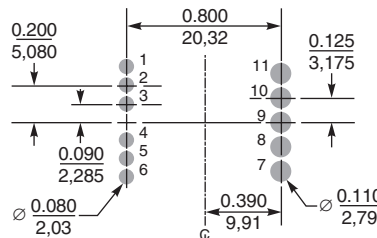
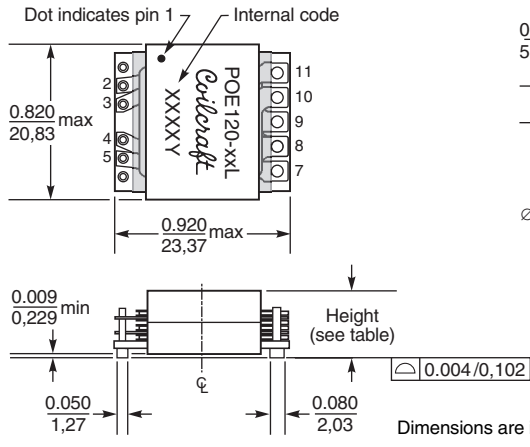

Recommended Land Pattern

Dash number	Height max (inches / mm)
-12L	0.352 / 8.94
-24L	0.380 / 9.64
-33L	0.407 / 10.34
-50L	0.375 / 9.53

Weight: 11.1 – 11.9 g

Packaging 36 per tray

Optional tape and reel packaging

POE120PL-12: 250/13" reel
 Plastic tape: 44 mm wide, 0.5 mm thick, 32 mm pocket spacing, 9.40 mm pocket depth

POE120PL-24: 200/13" reel
 Plastic tape: 44 mm wide, 0.5 mm thick, 28 mm pocket spacing, 9.98 mm pocket depth

POE120PL-33: 200/13" reel
 Plastic tape: 44 mm wide, 0.5 mm thick, 28 mm pocket spacing, 10.68 mm pocket depth

POE120PL-50: 250/13" reel
 Plastic tape: 44 mm wide, 0.5 mm thick, 32 mm pocket spacing, 9.78 mm pocket depth

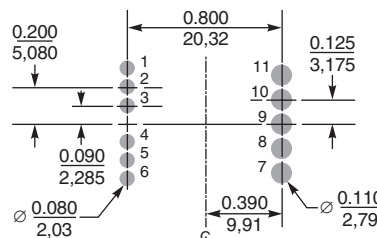
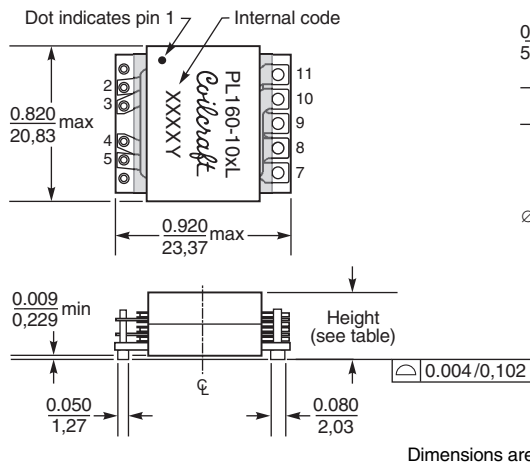

Recommended Land Pattern

Dash number	Height max (inches / mm)
-100L	0.352 / 8.94
-101L	0.352 / 8.94
-102L	0.360 / 9.14
-103L	0.375 / 9.53
-104L	0.375 / 9.53

Weight: 12.0 – 12.8 g

Packaging 36 per tray

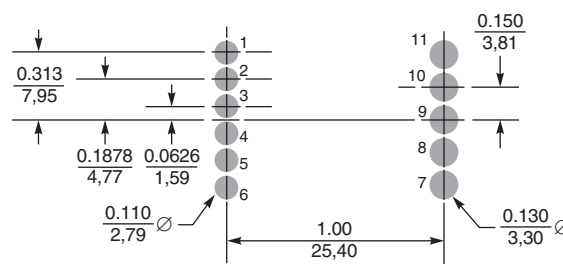
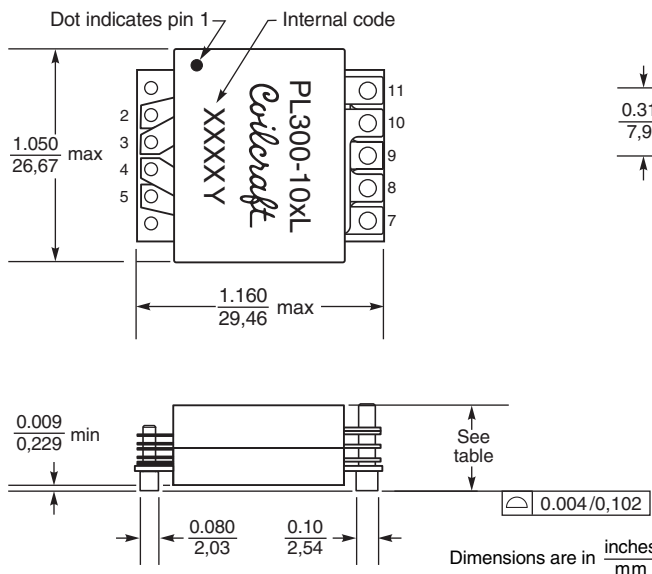

Recommended Land Pattern

Part number	Height max (in / mm)
PL300-100L	0.410 / 10.4
PL300-101L	0.410 / 10.4
PL300-102L	0.450 / 11.4
PL300-103L	0.450 / 11.4
PL300-104L	0.475 / 12.1

Weight: 22.5 – 26.0 g

Packaging 25 per tray



www.coilcraft.com

US +1-847-639-6400 sales@coilcraft.com
UK +44-1236-730595 sales@coilcraft-europe.com
Taiwan +886-2-2264 3646 sales@coilcraft.com.tw
China +86-21-6218 8074 sales@coilcraft.com.cn
Singapore + 65-6484 8412 sales@coilcraft.com.sg

Document 1280-4 Revised 11/16/15

© Coilcraft Inc. 2017

This product may not be used in medical or high risk applications without prior Coilcraft approval. Specification subject to change without notice. Please check web site for latest information.



Planar Transformers

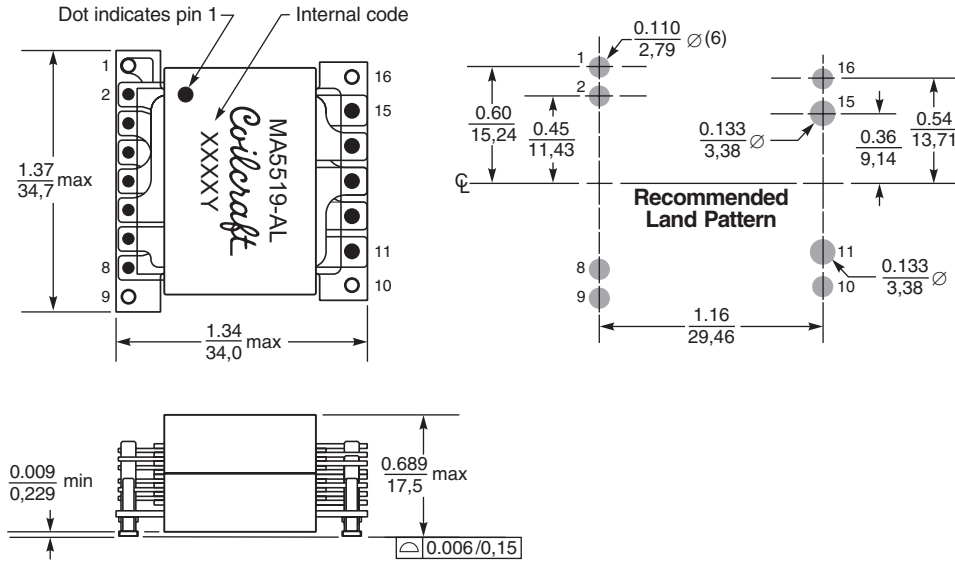

Weight: 53.9 g
Packaging 16 per tray

Dimensions are in $\frac{\text{inches}}{\text{mm}}$

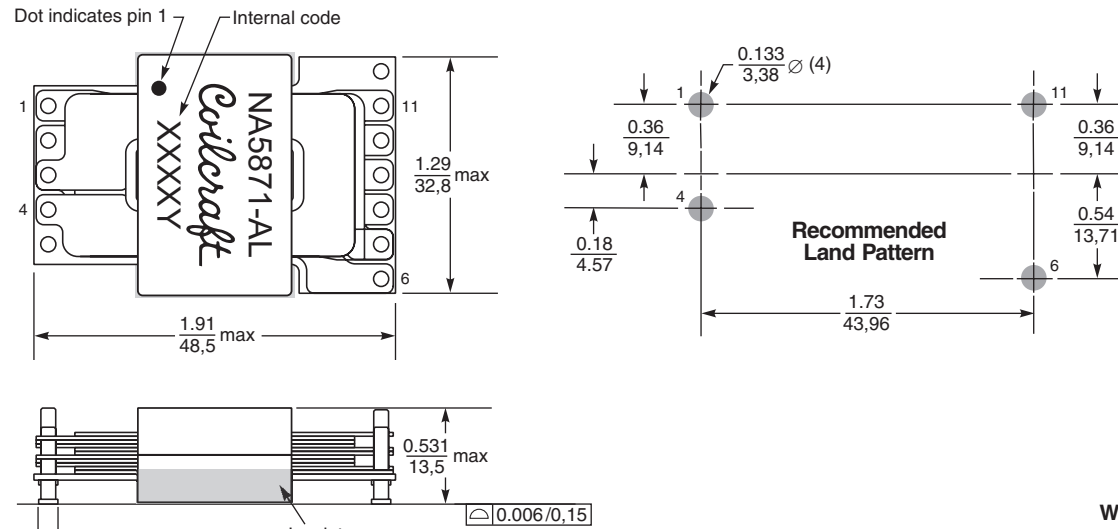

Weight: 60 g
Packaging 20 per tray

Dimensions are in $\frac{\text{inches}}{\text{mm}}$



US +1-847-639-6400 sales@coilcraft.com
UK +44-1236-730595 sales@coilcraft-europe.com
Taiwan +886-2-2264 3646 sales@coilcraft.com.tw
China +86-21-6218 8074 sales@coilcraft.com.cn
Singapore + 65-6484 8412 sales@coilcraft.com.sg

Document 1280-5 Revised 11/16/15
 © Coilcraft Inc. 2017
 This product may not be used in medical or high risk applications without prior Coilcraft approval. Specification subject to change without notice. Please check web site for latest information.



Planar Transformers

Coilcraft planar transformers have been designed in a wide variety of applications. Though designed for specific chipsets, these transformers can also be used in other applications and with many other integrated circuits. Visit www.coilcraft.com/prod_planar.cfm for additional information.

Power (W)	Output	Input voltage (V)	Turns	Part number	Primary L (µH)	DCR (mOhms)		Leakage L (µH)	Designed for
						Pri	Sec		
33	3.3 V, 10 A	36 – 75	24 : 4	A9784-BL	1300	0.85	0.016	3.5	TI LM5030
35	5 V, 7A	36 – 75	24 : 6	A0152-AL	1300	0.85	0.018	2.5	TI LM5030
40	12 V, 3.3 A	18 – 36	8 : 9 : 3	RA6998-BL	80	15	22	0.35	MAX17599
50	5 V, 10 A	36 – 78	4 : 2 : 2	HA3648-BL	30	6.0	3.0 3.0	0.04	TI LM5037
60	12 V, 5A	36 – 75	24 : 12	B0310-AL	1300	0.85	0.06	2.5	TI LM5030
60	12 V, 5A	9.0 – 60	5 : 5	PA6605-AL	10	4.7	4.7	0.13	TI LM5031
100	3.3 V, 30 A	35 – 78	6 : 1 : 1 : 4	JA4309-AL	67.5	20	0.5	0.65	TI UCC2897A
100	3.3 V, 30 A	35 – 78	12 : 2	B0357-BL	320	55	1.0	0.55	TI LM5025
100	3.3 V, 30 A	36 – 78	12 : 1 : 1	HA4000-AL	270	56	0.5	0.6	TI LM5027
100	12 V, 8.33 A	12 – 45	24 : 12	C1539-AL	320	63	15	0.25	TI LM5032
100	3.3 V, 30 A	36 – 75	8 : 4	DA2025-AL	120	50	2.0	0.25	TI LM5035
100	3.3 V, 30 A	85 – 400	6 : 1	B0392-AL	65	13.5	0.40	0.22	TI UCC3580
150	2.5 V 60 A	36 – 75	16 : 1	A9786-AL	1250	62.5	0.91	0.90	TI LM5041
150	12 V, 12.5 A	18 – 72	4 : 4 : 4	PL160-100L	153	7.35	6.8	0.35	LT DC1739A-B
150	12 V 13 A	48– 60	12 : 3 : 3	RA7040-AL	50	10.75	4.25	0.55	TI PMP9720
180	12 V, 15 A	36 – 72	10 : 4	B0860-CL	187	38	4.0	0.25	MAX5069A
200	10 V, 20 A	40 – 60	5 : 4	B0853-AL	46.8	10.4	4.0	0.10	TI LM5033
250	12 V 21 A	48 – 60	8 : 4 : 4	RA6992-BL	50	6.9	4.2	0.25	TI PMP9656
264	12 V 22 A	52 – 60	5 : 2 : 2	NA5738-DL	100	4.8	1.7	0.18	TI PMP7376
720	12 V, 60 A	36 – 75	6 : 2 : 2	MA5519-AL	190.8	5.0	1.53	0.13	TI PMP9219
800	54 V, 15 A	38 – 60	3 : 5	NA5871-AL	42.0	1.37	4.4	0.20	TI PMP6712



www.coilcraft.com

US +1-847-639-6400 sales@coilcraft.com
UK +44-1236-730595 sales@coilcraft-europe.com
Taiwan +886-2-2264 3646 sales@coilcraft.com.tw
China +86-21-6218 8074 sales@coilcraft.com.cn
Singapore + 65-6484 8412 sales@coilcraft.com.sg

Document 1280-6 Revised 11/16/15

© Coilcraft Inc. 2017

This product may not be used in medical or high risk applications without prior Coilcraft approval. Specification subject to change without notice. Please check web site for latest information.