



# Magnetics for LM258x Flyback Regulator

These standard flyback regulator transformers are designed for use with Texas Instruments LM2585, LM2586, LM2587 and LM2588 **SIMPLE SWITCHER**® switching regulators.

They are available in surface mount and through hole configurations. All feature 500 V isolation between windings and a variety of available turns ratios.

Ref. number	Part number	Input voltage (V)	Inductance at 0 Adc ±15% (µH)	Inductance at Ipk min (µH)	Volt-time product max (Vµsec)	Leakage Inductance <sup>1</sup> max (µH)	DCR (Ohms)		Turns ratio pri : sec	Output	Ipk <sup>2</sup> (A)
							pri	sec			
T1 (SM)	Q4435-BL	4 – 6	22	19.0	166.5	0.7	0.020	0.025	1:1	5 V, 1.6 A	4.85
T1 (PC)	Q4434-BL	4 – 6	22	19.8	162.0	2.0	0.028	0.028	1:1	5 V, 1.6 A	5.0
T2 (SM)	Q4436-BL	4 – 6	22	17.6	166.5	0.5	0.025	0.23 (10-11) 0.25 (9-8)	1:2.5 1:2.5	12 V, 0.35 A 12 V, 0.35 A	5.0
T2 (PC)	Q4337-BL	4 – 6	22	19.8	162.0	2.0	0.030	0.32 (8-7) 0.32 (6-5)	1:2.5 1:2.5	12 V, 0.35 A 12 V, 0.35 A	5.0
T3 (PC)	Q4343-BL	18 – 36	85	76.5	364.5	3.5	0.150	0.011 (10-9) 0.011 (7-6)	1:0.8 1:0.8	12 V, 1.4 A 12 V, 1.4 A	3.0
T4 (PC)	Q4344-BL	18 – 36	85	76.5	364.5	3.5	0.145	0.20 (10-9) 0.20 (7-6) 0.03 (4-5)	1:0.8 1:0.8 1:0.35	12 V, 0.75 A 12 V, 0.75 A 5 V, 3.0 A	3.0
T5 (SM)	Q4437-BL	18 – 36	55	47.3	299.7	2.0	0.110	0.035 (10-11) 0.30 (9-8) 0.32 (4-5)	1:0.5 1:1.167 1:1.167	5 V, 1.8 A 12 V, 0.25 A 12 V, 0.25 A	3.0
T5 (PC)	Q4338-BL	18 – 36	66	59.4	499.5	3.5	0.090	0.039 (8-7) 0.58 (6-5) 0.60 (3-4)	1:0.5 1:1.167 1:1.167	5 V, 1.8 A 12 V, 0.25 A 12 V, 0.25 A	3.0
T6 (SM)	Q4438-BL	18 – 36	65	57.0	299.7	3.0	0.065	0.15 (10-11) 0.15 (9-8)	1:1.2 1:1.2	12 V, 0.63 A 12 V, 0.63 A	3.0
T6 (PC)	Q4339-BL	18 – 36	66	59.4	499.5	3.0	0.090	0.20 (8-7) 0.24 (5-6)	1:1.2 1:1.2	12 V, 0.63 A 12 V, 0.63 A	3.0
T7 (SM)	S6057-AL	4 – 6	47	40.0	233.1	2.0	0.065	0.065	1:1	5 V, 0.9 A	3.0
T7 (PC)	S6000-AL	4 – 6	47	40.0	212.6	2.0	0.065	0.042	1:1	5 V, 0.9 A	3.0

1. Leakage inductance measured across the primary at 0.10 Vrms, 100 kHz.
  2. DC current at which the primary inductance is measured.
  3. Electrical specifications at 25°C.
- Refer to Doc 362 "Soldering Surface Mount Components" before soldering.

**Core material** Ferrite

**Ambient temperature** –40°C to +85°C

**Weight**

<b>Q4337-BL:</b>	11.4 g	<b>Q4435-BL:</b>	9.0 g
<b>Q4338-BL:</b>	11.5 g	<b>Q4436-BL:</b>	8.7 g
<b>Q4339-BL:</b>	11.6 g	<b>Q4437-BL:</b>	8.2 g
<b>Q4343-BL:</b>	25.1 g	<b>Q4438-BL:</b>	8.6 g
<b>Q4344-BL:</b>	23.1 g	<b>S6000-AL:</b>	10.6 g
<b>Q4434-BL:</b>	11.5 g	<b>S6057-AL:</b>	8.2 g

**Storage temperature** Component: –40°C to +85°C.

Tray packaging: –40°C to +80°C

**Resistance to soldering heat (SM parts)** Max three 40 second reflows at +260°C, parts cooled to room temperature between cycles

**Moisture Sensitivity Level (MSL)** 1 (unlimited floor life at <30°C / 85% relative humidity)

**Failures in Time (FIT) / Mean Time Between Failures (MTBF)**

38 per billion hours / 26,315,789 hours, calculated per Telcordia SR-332

**PCB washing** Tested with pure water or alcohol only. For other solvents, see Doc787\_PCB\_Washing.pdf.



www.coilcraft.com

**US** +1-847-639-6400 sales@coilcraft.com  
**UK** +44-1236-730595 sales@coilcraft-europe.com  
**Taiwan** +886-2-2264 3646 sales@coilcraft.com.tw  
**China** +86-21-6218 8074 sales@coilcraft.com.cn  
**Singapore** + 65-6484 8412 sales@coilcraft.com.sg

Document 183-1 Revised 11/01/12

© Coilcraft Inc. 2014

This product may not be used in medical or high risk applications without prior Coilcraft approval. Specification subject to change without notice. Please check web site for latest information.



# Magnetics for LM258x Flyback Regulator

## Schematics – Surface Mount (SM)

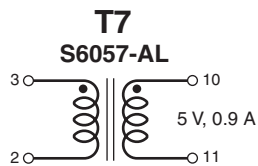
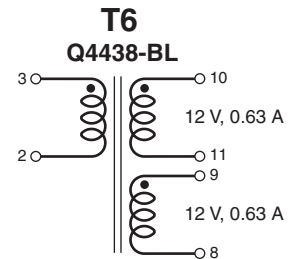
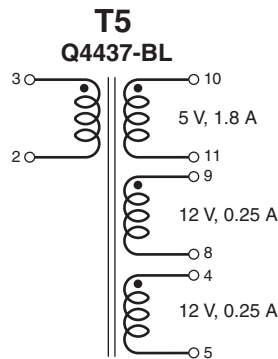
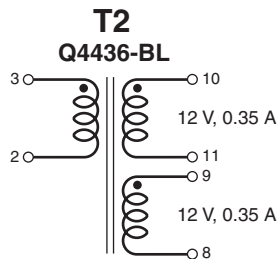
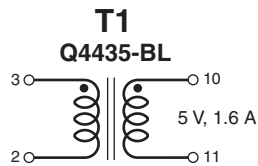

## Schematics – Leaded (PC)

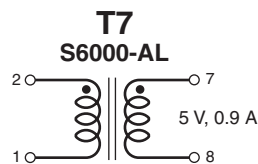
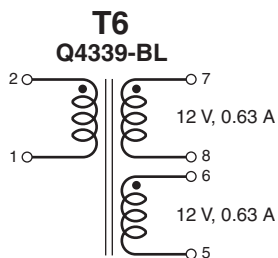
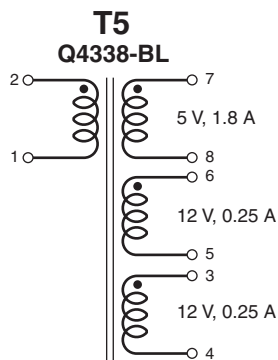
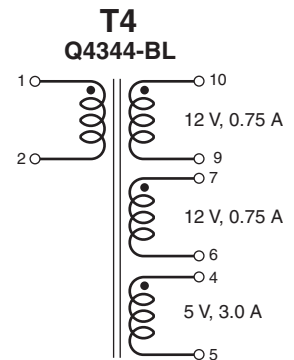
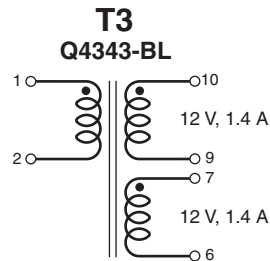
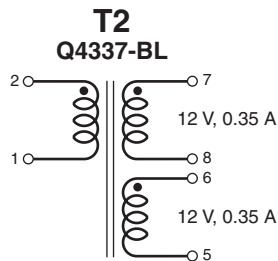
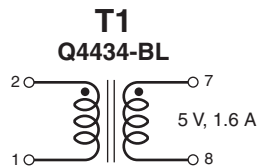



# Magnetics for LM258x Flyback Regulator

## Surface Mount (Q4435-BL, Q4436-BL, Q4437-BL, Q4438-BL, S6057-AL)

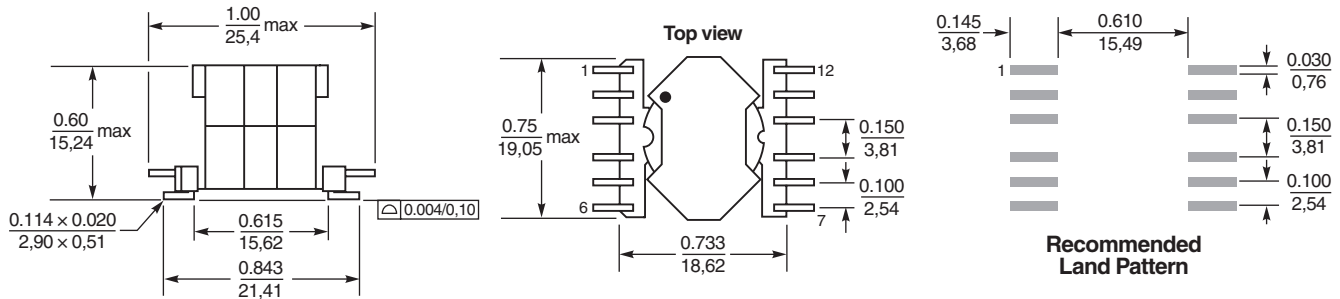

**Terminations** RoHS tin-silver over tin over copper clad steel.  
Packaged 49 parts per tray

Dimensions are in  $\frac{\text{inches}}{\text{mm}}$

## Leaded – T1, T2, T5, T6, T7 (Q4434-BL, Q4337-BL, Q4338-BL, Q4339-BL, S6000-AL)

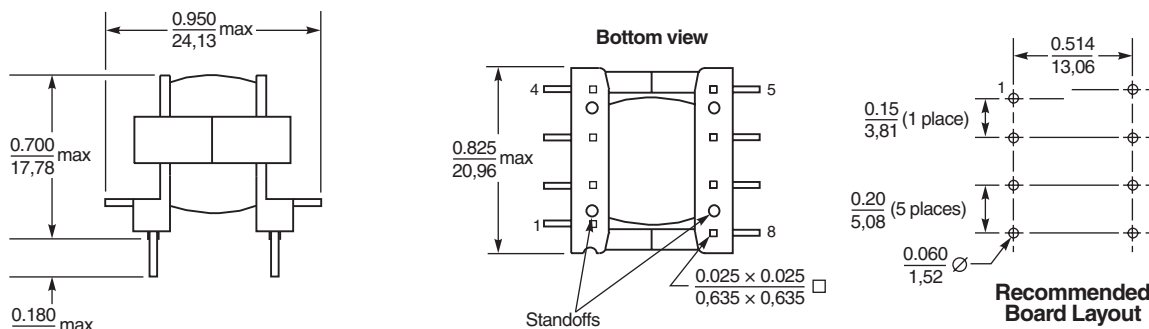

**Terminations** RoHS tin-silver over tin over nickel over phos bronze.  
Packaged 49 parts per tray

Dimensions are in  $\frac{\text{inches}}{\text{mm}}$

## Leaded – T3, T4 (Q4343-BL, Q4344-BL)

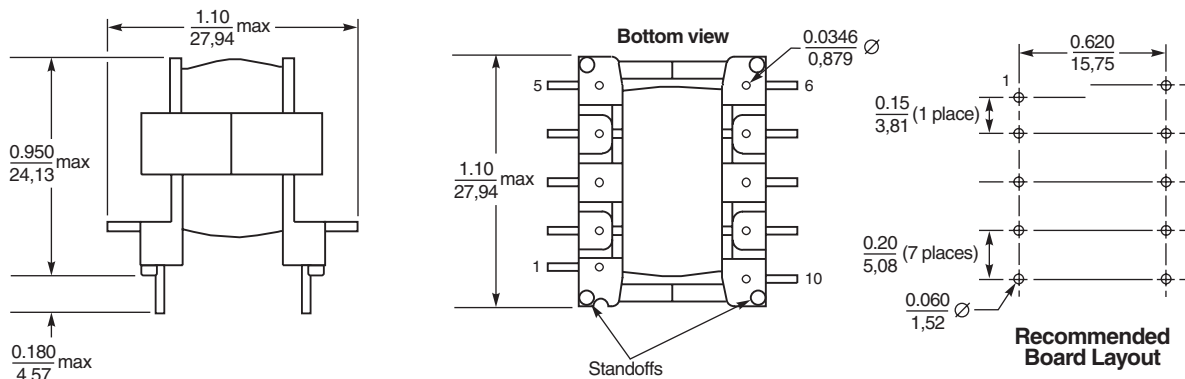

**Terminations** RoHS tin-silver over tin over copper.  
Packaged 30 parts per tray

Dimensions are in  $\frac{\text{inches}}{\text{mm}}$



www.coilcraft.com

**US** +1-847-639-6400 sales@coilcraft.com  
**UK** +44-1236-730595 sales@coilcraft-europe.com  
**Taiwan** +886-2-2264 3646 sales@coilcraft.com.tw  
**China** +86-21-6218 8074 sales@coilcraft.com.cn  
**Singapore** + 65-6484 8412 sales@coilcraft.com.sg

Document 183-3 Revised 11/01/12

© Coilcraft Inc. 2014

This product may not be used in medical or high risk applications without prior Coilcraft approval. Specification subject to change without notice. Please check web site for latest information.