

NEW!

Shielded Power Inductors – XGL3014

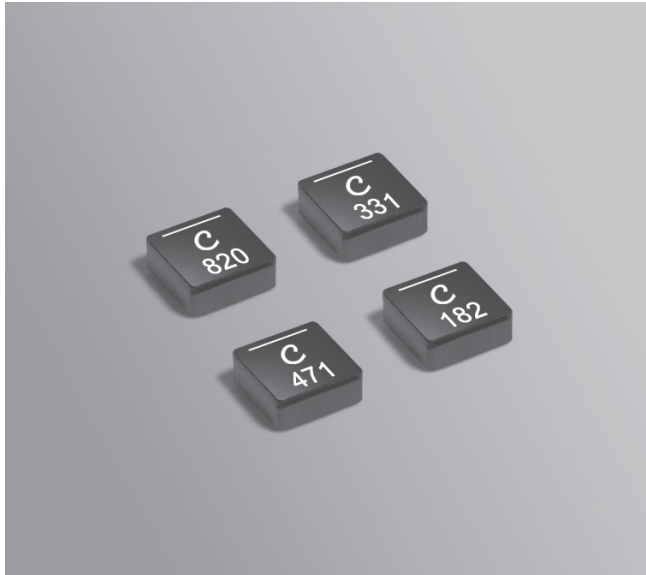

- Industry's lowest DCR and ultra low AC losses
- AEC-Q200 Grade 1 (–40°C to +125°C)
- Superior current handling with soft saturation characteristics
- Wide inductance range from 0.082 to 1.8 μ H

Core material Composite**Core and winding loss** See www.coilcraft.com/coreloss**Environmental** RoHS compliant, halogen free**Terminations** RoHS compliant tin-silver (96.5/3.5) over copper. Other terminations available at additional cost.**Weight:** 0.063 – 0.068 g**Operating voltage:** 0 – 80 V**Ambient temperature** –40°C to +125°C with (40°C rise) Irms current.**Maximum part temperature** +165°C (ambient + temp rise). [Derating](#).**Storage temperature** Component: –55°C to +165°C.

Tape and reel packaging: –55°C to +80°C

Resistance to soldering heat Max three 40 second reflows at +260°C, parts cooled to room temperature between cycles**Moisture Sensitivity Level (MSL)** 1 (unlimited floor life at <30°C / 85% relative humidity)**Packaging** 2000/7" reel; 7500/13" reel Plastic tape: 8 mm wide, 0.23 mm thick, 8 mm pocket spacing, 1.55 mm pocket depth**PCB washing** Tested to MIL-STD-202 Method 215 plus an additional aqueous wash. See [Doc787_PCB_Washing.pdf](#).

Part number ¹	Inductance ² $\pm 20\%$ (μ H)	DCR (mOhms) ³		SRF typ ⁴ (MHz)	Isat (A) ⁵			Irms (A) ⁶	
		typ	max		10% drop	20% drop	30% drop	20°C rise	40°C rise
XGL3014-820ME_	0.082	2.2	2.6	430	7.1	11.4	16.1	15.0	23.5
XGL3014-101ME_	0.10	2.6	3.1	380	6.5	10.1	13.9	13.8	21.5
XGL3014-201ME_	0.20	5.0	5.9	220	4.3	6.7	8.7	11.3	15.0
XGL3014-331ME_	0.33	7.3	8.7	150	3.3	5.1	7.4	8.9	12.3
XGL3014-471ME_	0.47	9.8	11.7	120	2.6	4.2	6.0	6.5	9.3
XGL3014-651ME_	0.65	13.7	16.4	110	2.2	3.5	5.0	6.2	8.3
XGL3014-801ME_	0.80	16.1	19.3	90	2.1	3.3	4.5	5.8	7.9
XGL3014-102ME_	1.0	19.0	22.7	75	1.9	3.0	4.1	5.3	7.1
XGL3014-142ME_	1.4	30.6	36.7	60	1.6	2.4	3.3	4.2	5.6
XGL3014-182ME_	1.8	38.1	45.7	55	1.3	2.1	3.0	4.1	5.6

1. When ordering, please specify **termination** and **packaging** codes:**XGL3014-182MEC****Termination:** E = RoHS compliant tin-silver over copper.**Special order:** T = RoHS tin-silver-copper (95.5/4/0.5) or S = non-RoHS tin-lead (63/37).**Packaging:** C = 7" machine-ready reel. EIA-481 embossed plastic tape (2500 per full reel).
Quantities less than full reel available: in tape (not machine ready) or with leader and trailer (\$25 charge).D = 13" machine-ready reel. EIA-481 embossed plastic tape (7500 per full reel).
Factory order only, not stocked.

2. Inductance tested at 1 MHz, 0.1 Vrms, 0 Adc.

3. DCR measured on a micro-ohmmeter.

4. SRF measured using Agilent/HP 4395A or equivalent.

5. DC current at 25°C that causes the specified inductance drop from its value without current.

[Click for temperature derating information.](#)

6. Current that causes the specified temperature rise from 25°C ambient.

This information is for reference only and does not represent absolute maximum ratings.

[Click for temperature derating information.](#)

7. Electrical specifications at 25°C.

Refer to Doc 362 "Soldering Surface Mount Components" before soldering.

Irms Testing

Irms testing was performed on 0.75 inch wide \times 0.25 inch thick copper traces in still air.

Temperature rise is highly dependent on many factors including pcb land pattern, trace size, and proximity to other components. Therefore temperature rise should be verified in application conditions.

SPICE models
ON OUR WEB SITEwww.coilcraft.com**US** +1-847-639-6400 sales@coilcraft.com**UK** +44-1236-730595 sales@coilcraft-europe.com**Taiwan** +886-2-2264 3646 sales@coilcraft.com.tw**China** +86-21-6218 8074 sales@coilcraft.com.cn**Singapore** + 65-6484 8412 sales@coilcraft.com.sg

Document 1703-1 Revised 08/04/22

© Coilcraft Inc. 2023

This product may not be used in medical or high risk applications without prior Coilcraft approval. Specification subject to change without notice. Please check web site for latest information.



Shielded Power Inductors - XGL3014

L vs Current

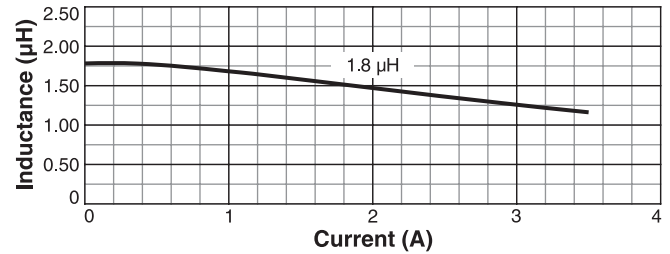
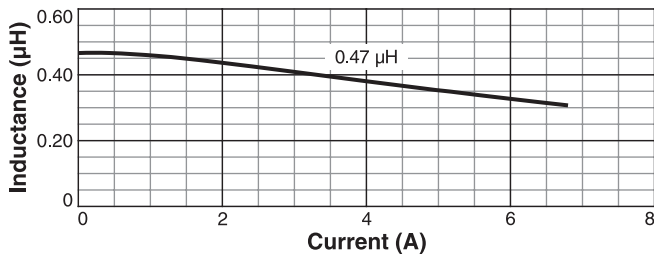
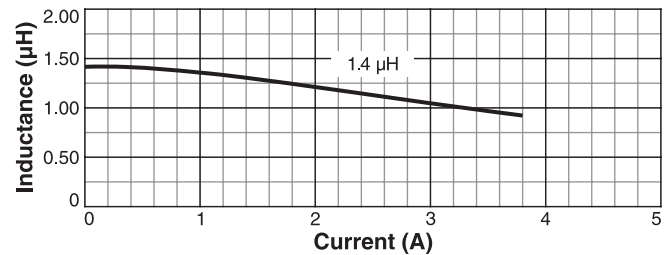
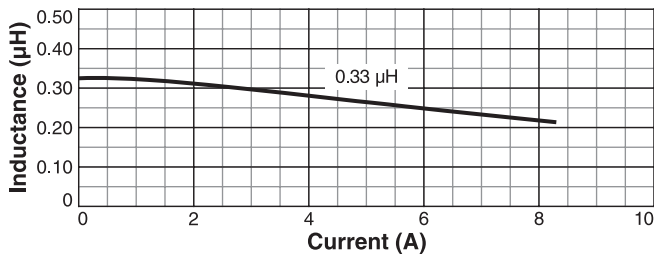
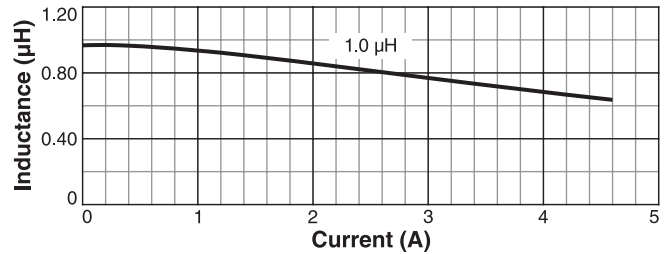
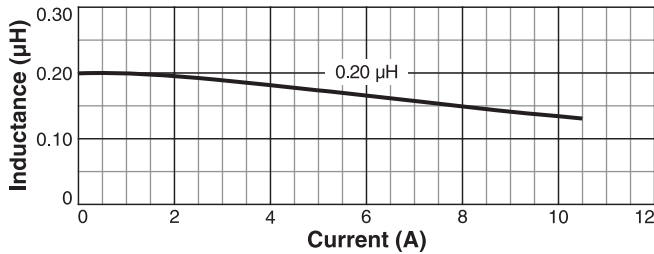
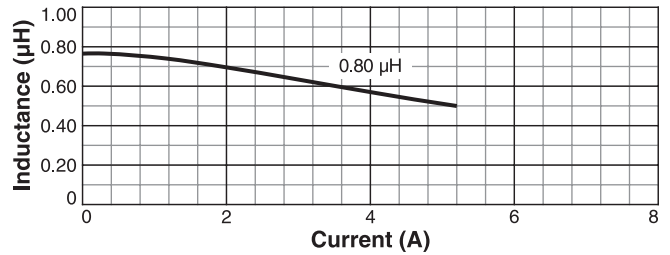
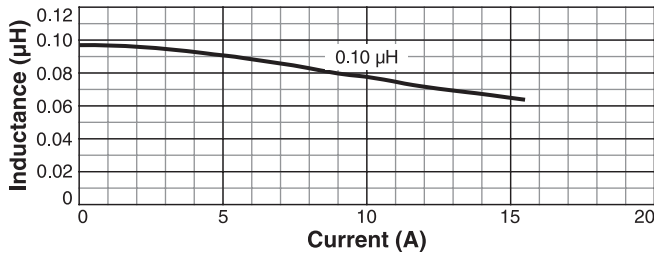
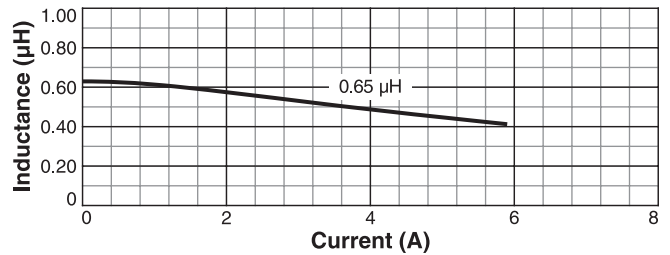
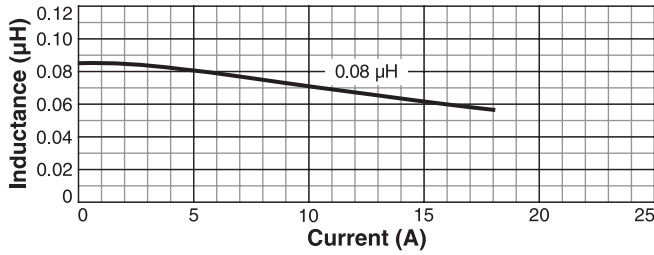

US +1-847-639-6400 sales@coilcraft.com
UK +44-1236-730595 sales@coilcraft-europe.com
Taiwan +886-2-2264 3646 sales@coilcraft.com.tw
China +86-21-6218 8074 sales@coilcraft.com.cn
Singapore + 65-6484 8412 sales@coilcraft.com.sg

Document 1703-2 Revised 08/04/22

© Coilcraft Inc. 2023

This product may not be used in medical or high risk applications without prior Coilcraft approval. Specification subject to change without notice. Please check web site for latest information.



Shielded Power Inductors - XGL3014

Typical L vs Frequency

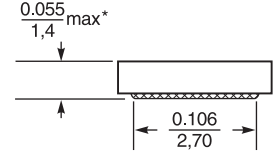
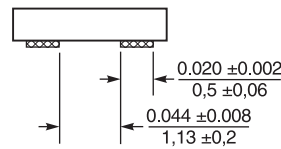
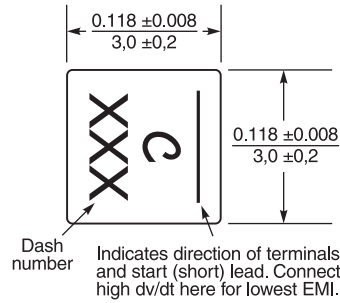
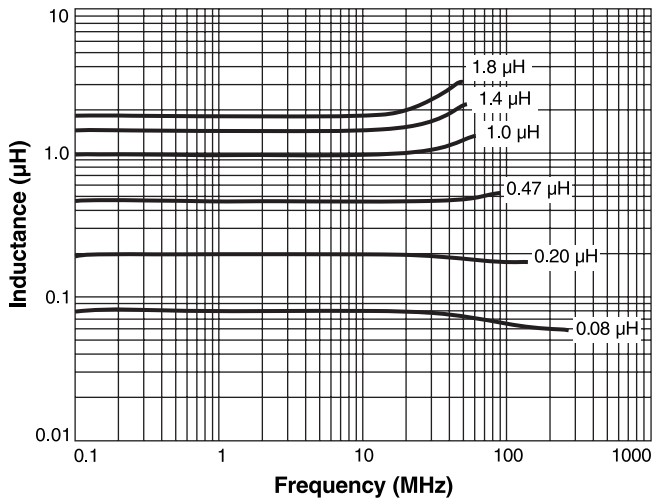

* For optional tin-lead and tin-silver-copper terminations, dimensions are for the mounted part. Dimensions before mounting can be an additional 0.005 inch / 0.13 mm.

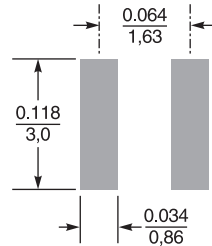

Recommended Land Pattern

Dimensions are in $\frac{\text{inches}}{\text{mm}}$